



Fieseler Fi 156 "Storch"

1 / 4 s c a l e R C



P H O T O A L B U M



1 FUSELAGE

NOTE:

The pictures are of the prototype.
In the serial production we have made some improvements.

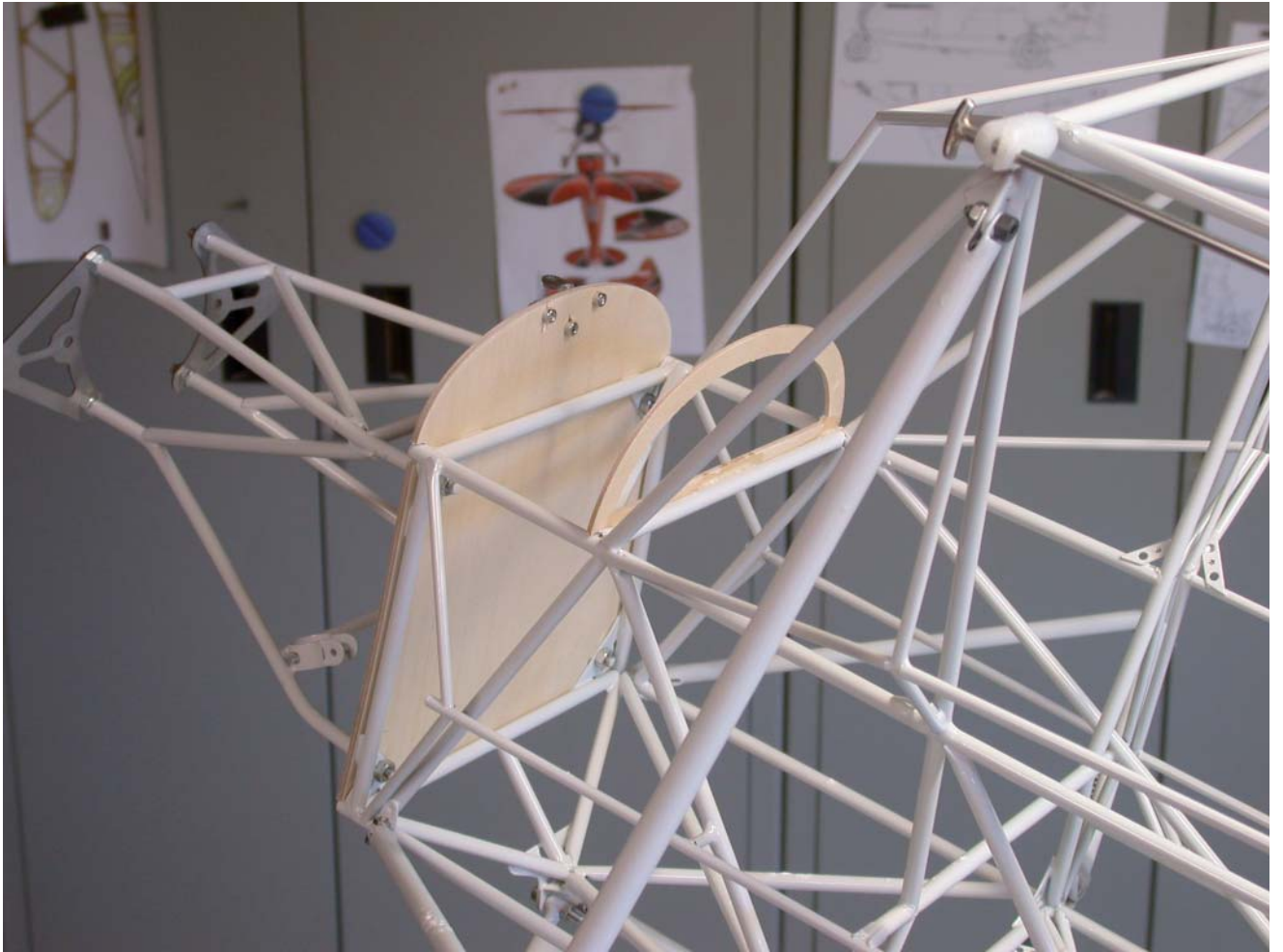

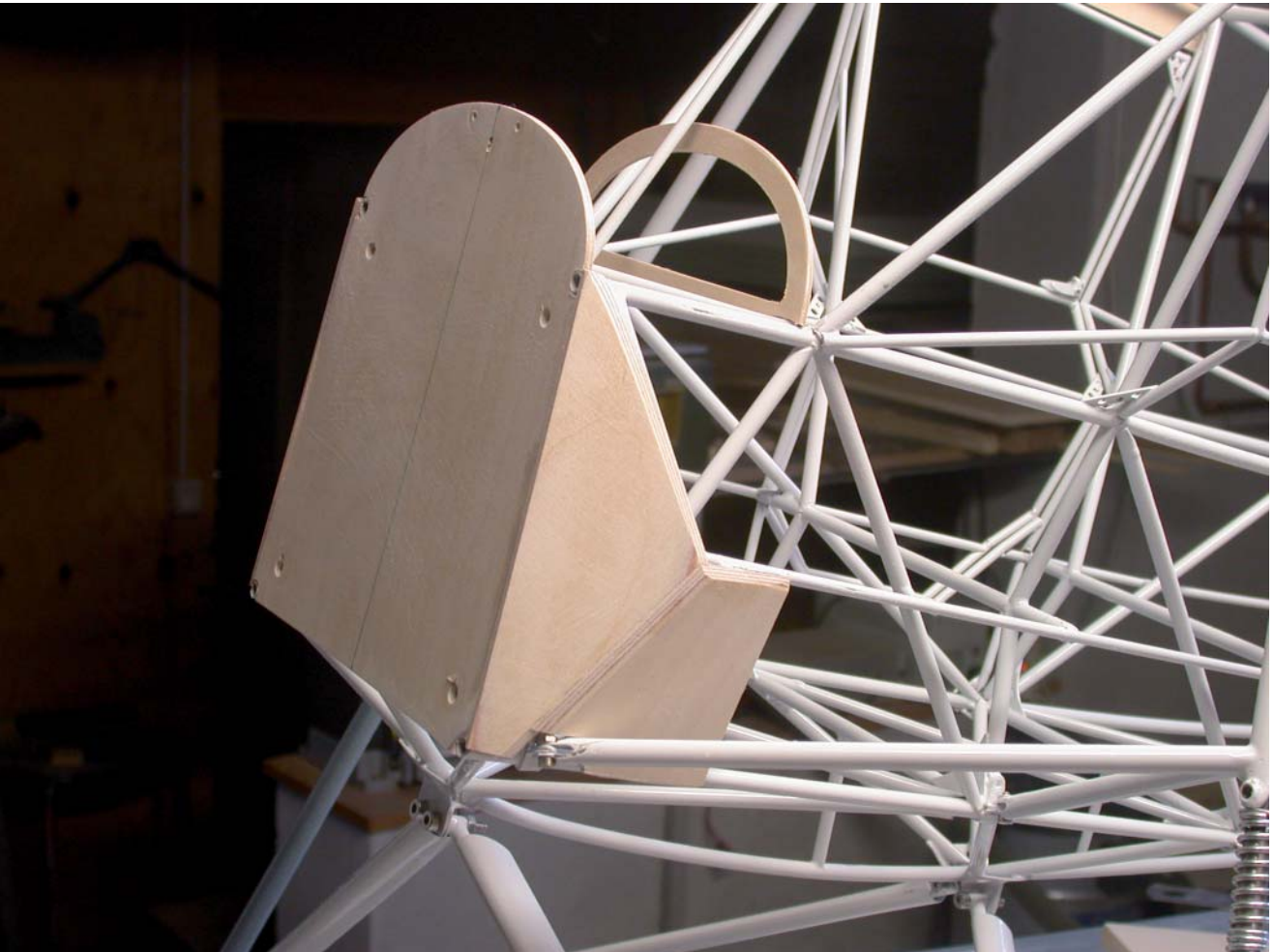
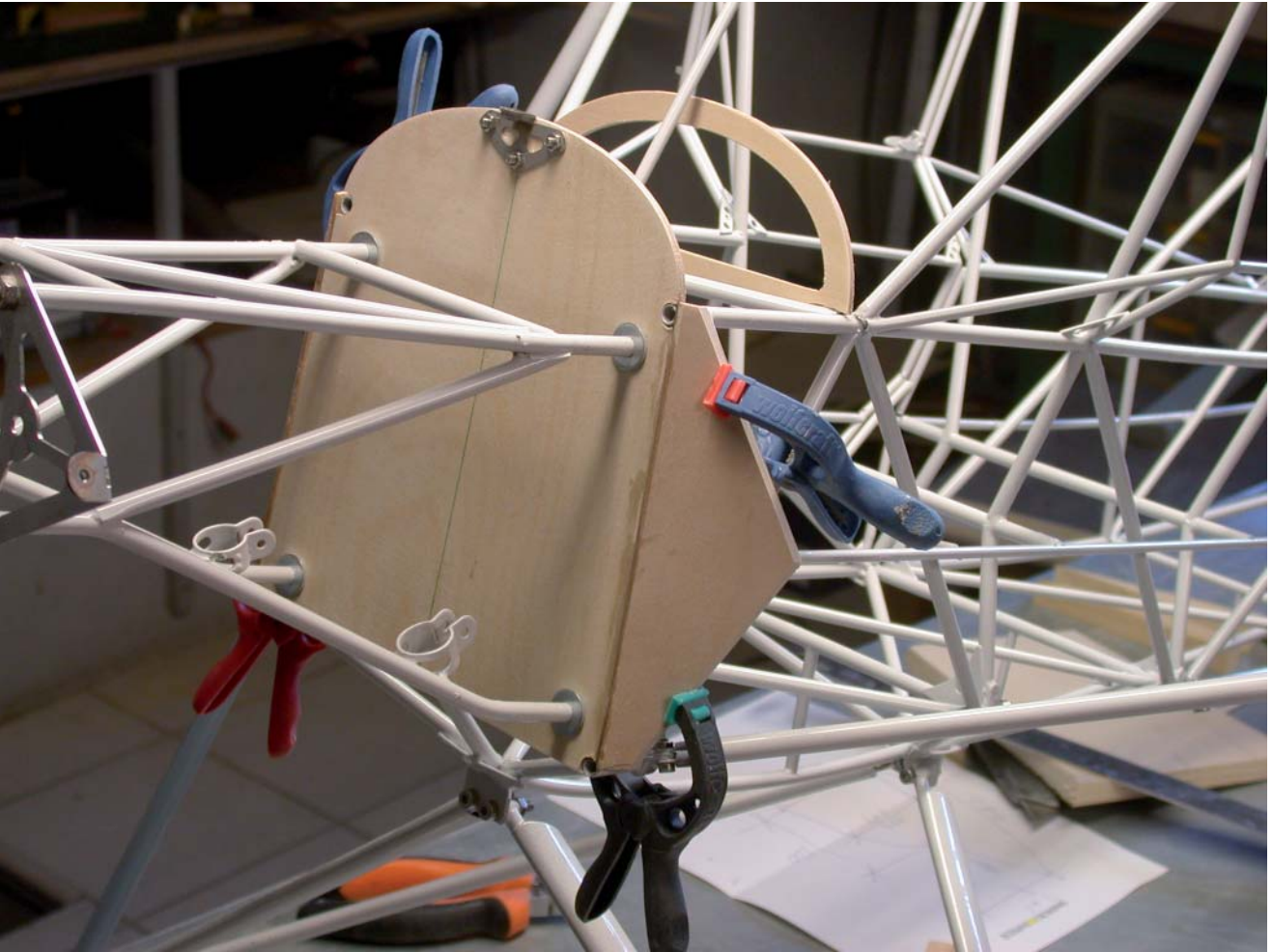

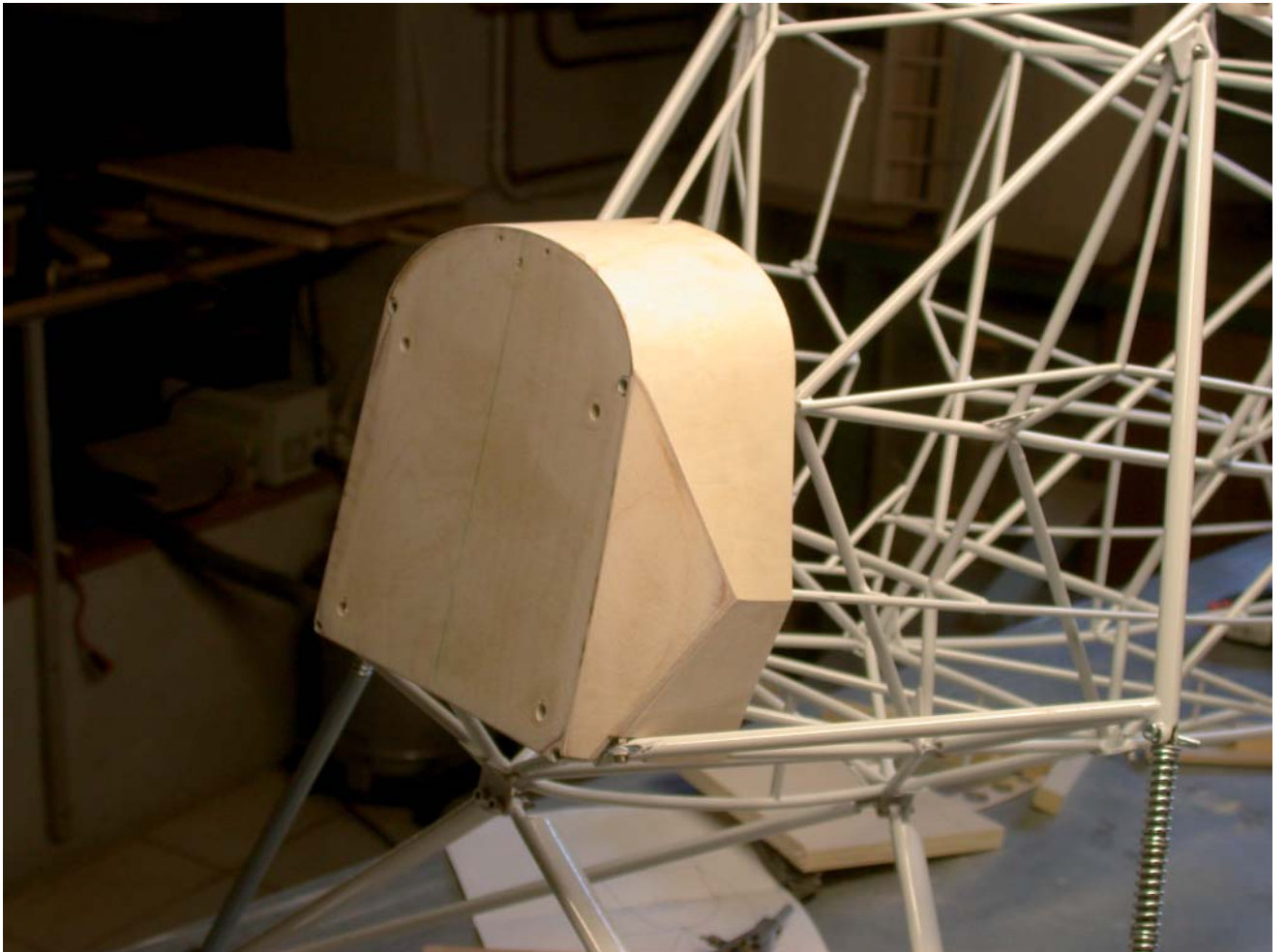
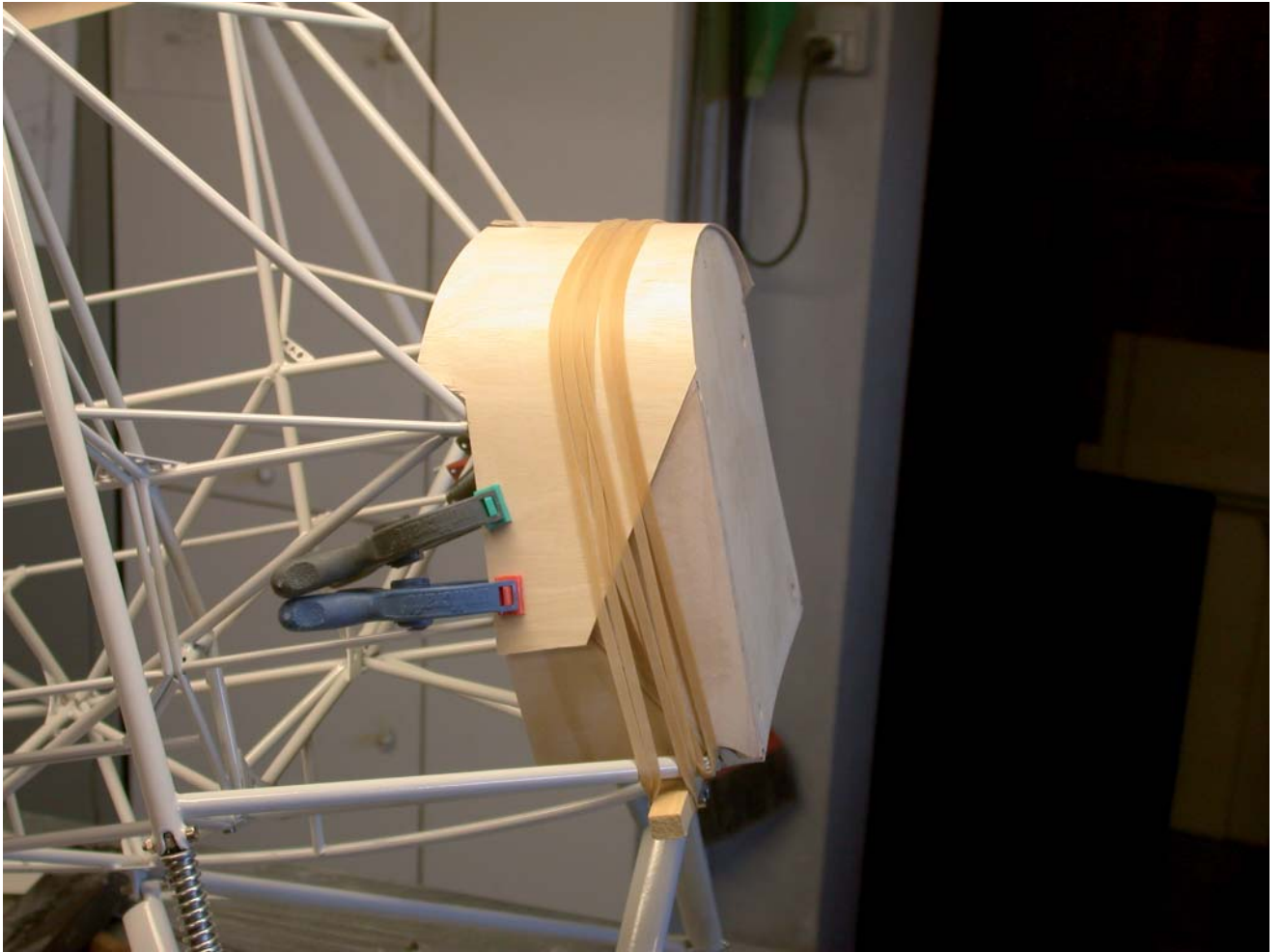

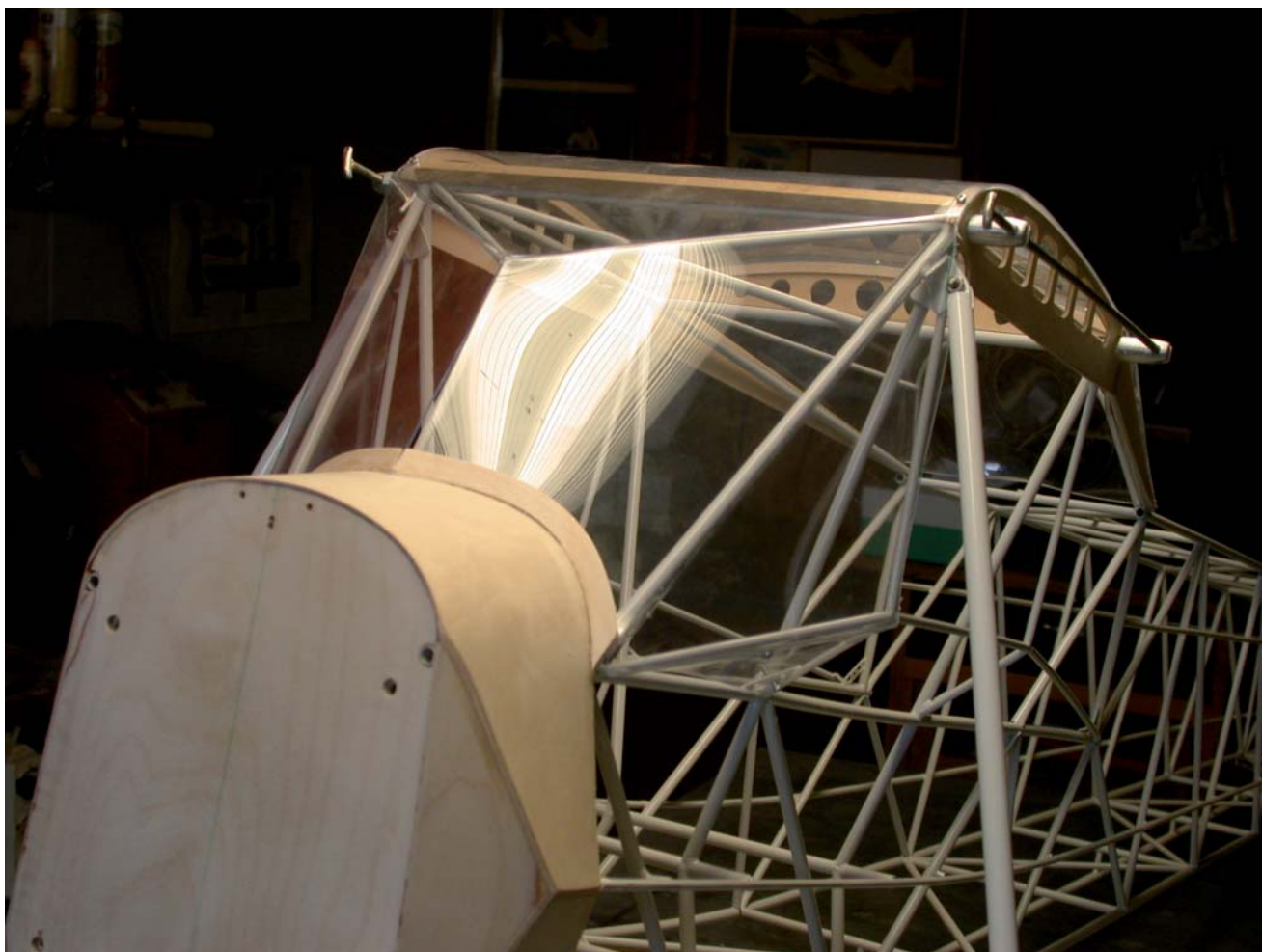
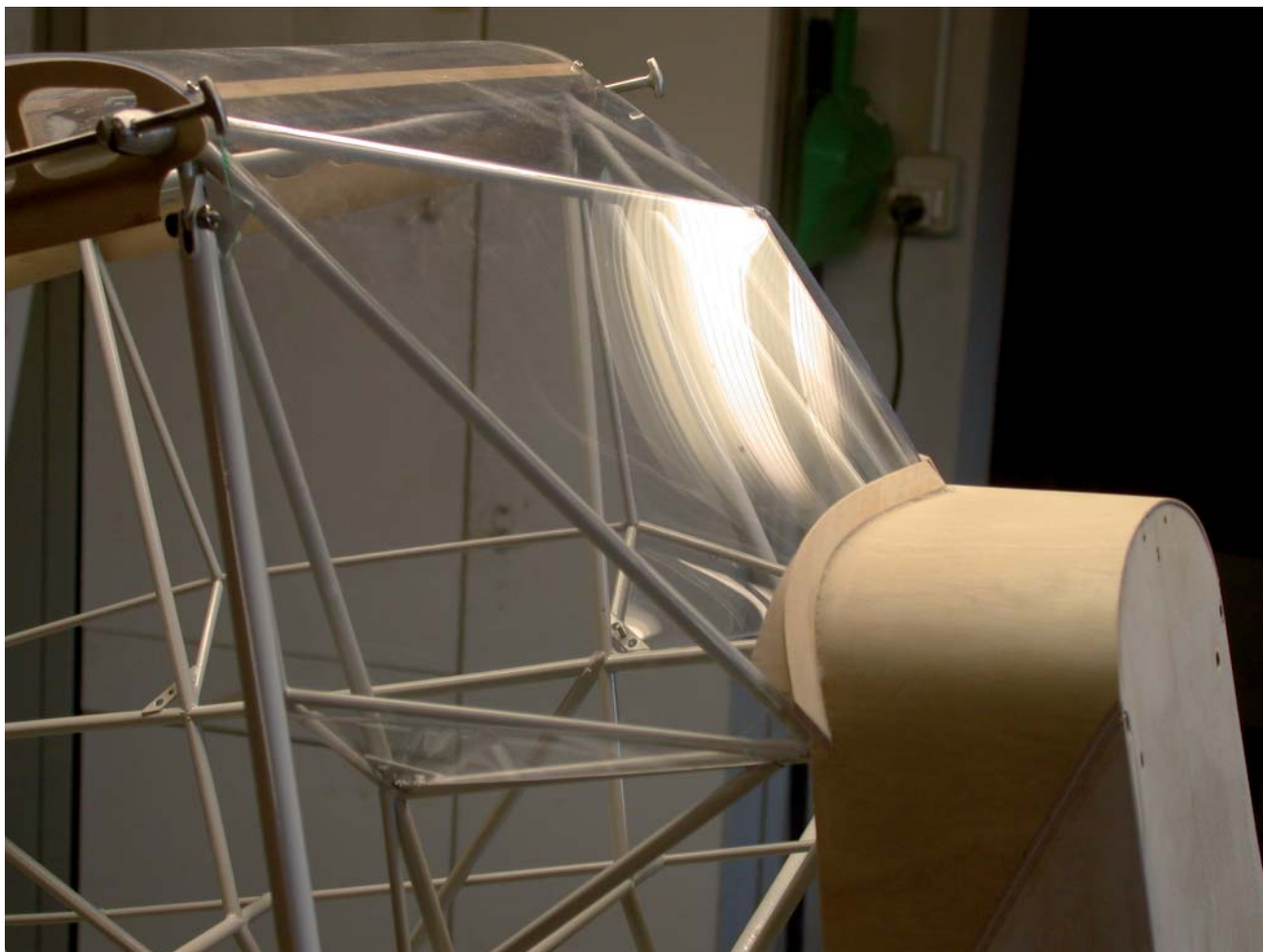

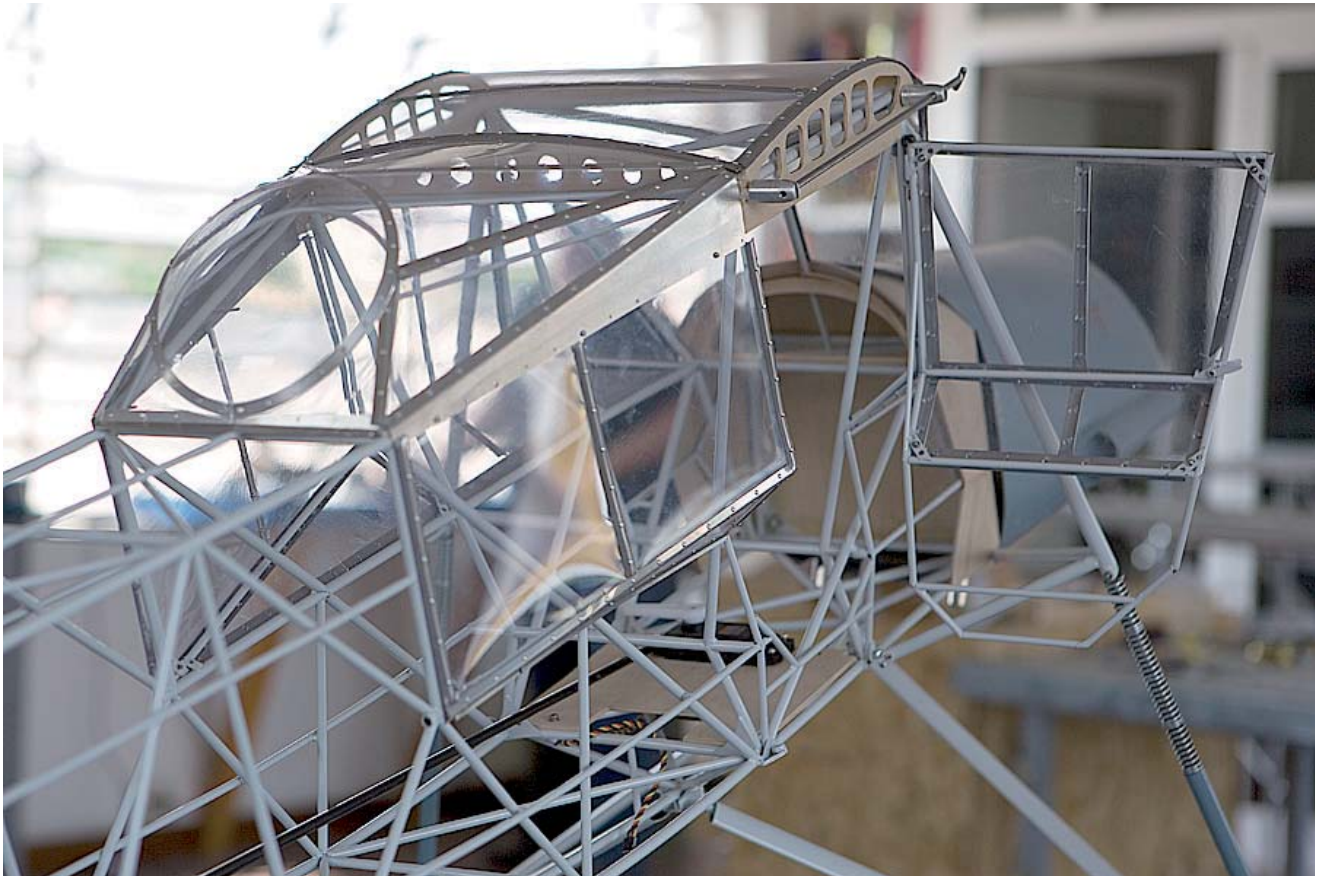

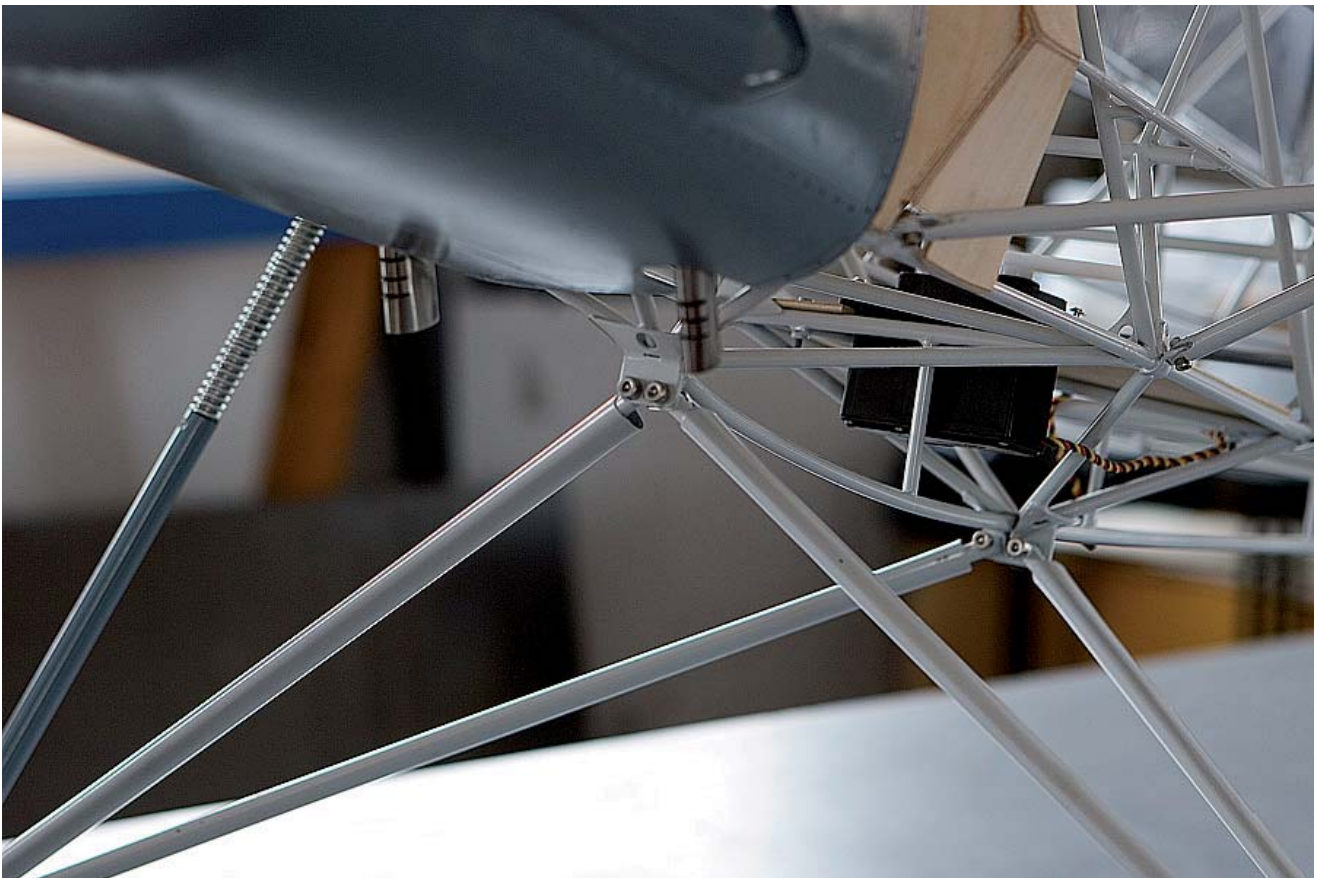



MODIFY LASER CRANKCASE FOR SCALE MOUNTING
(CUT THE CORNER)

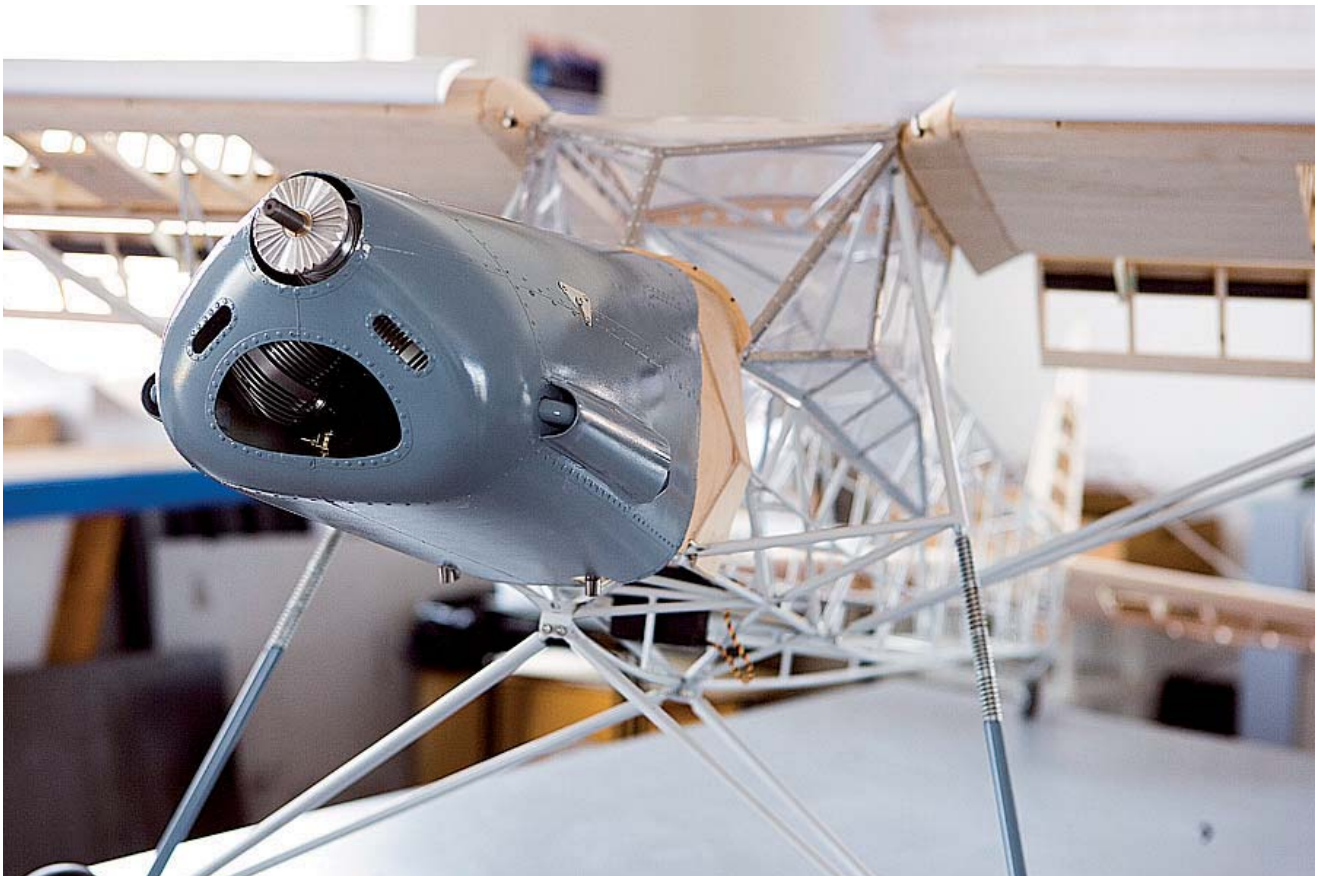

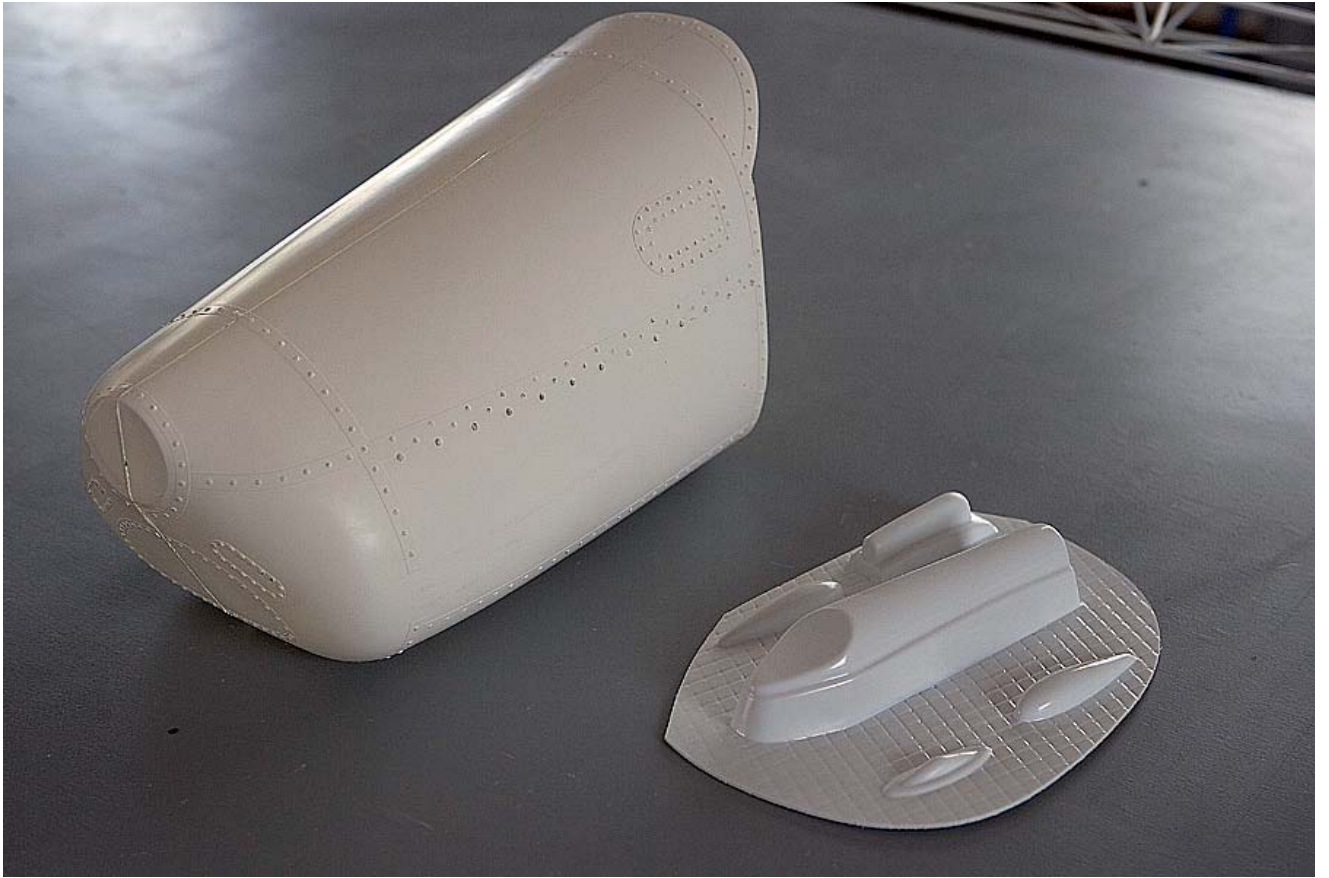

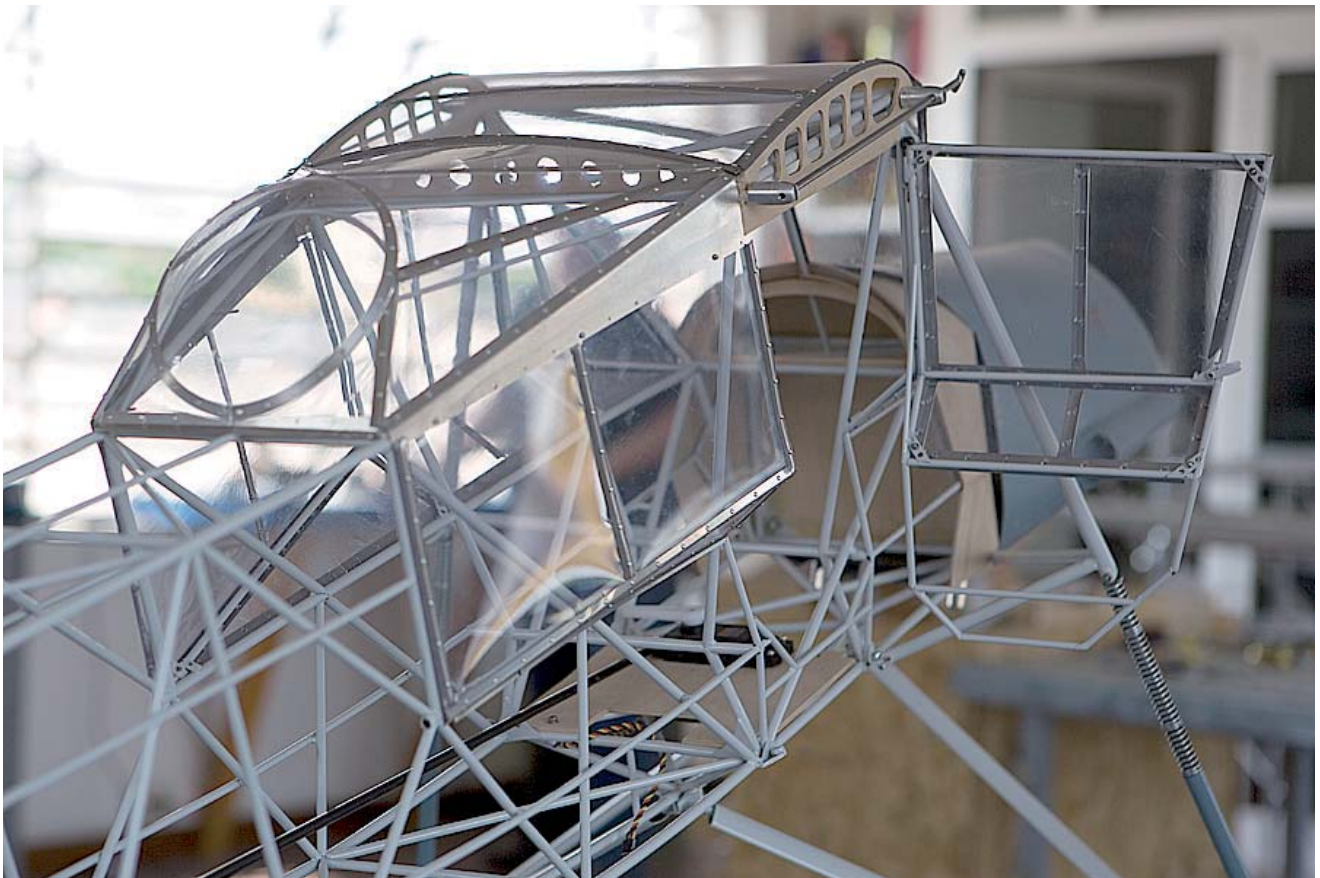

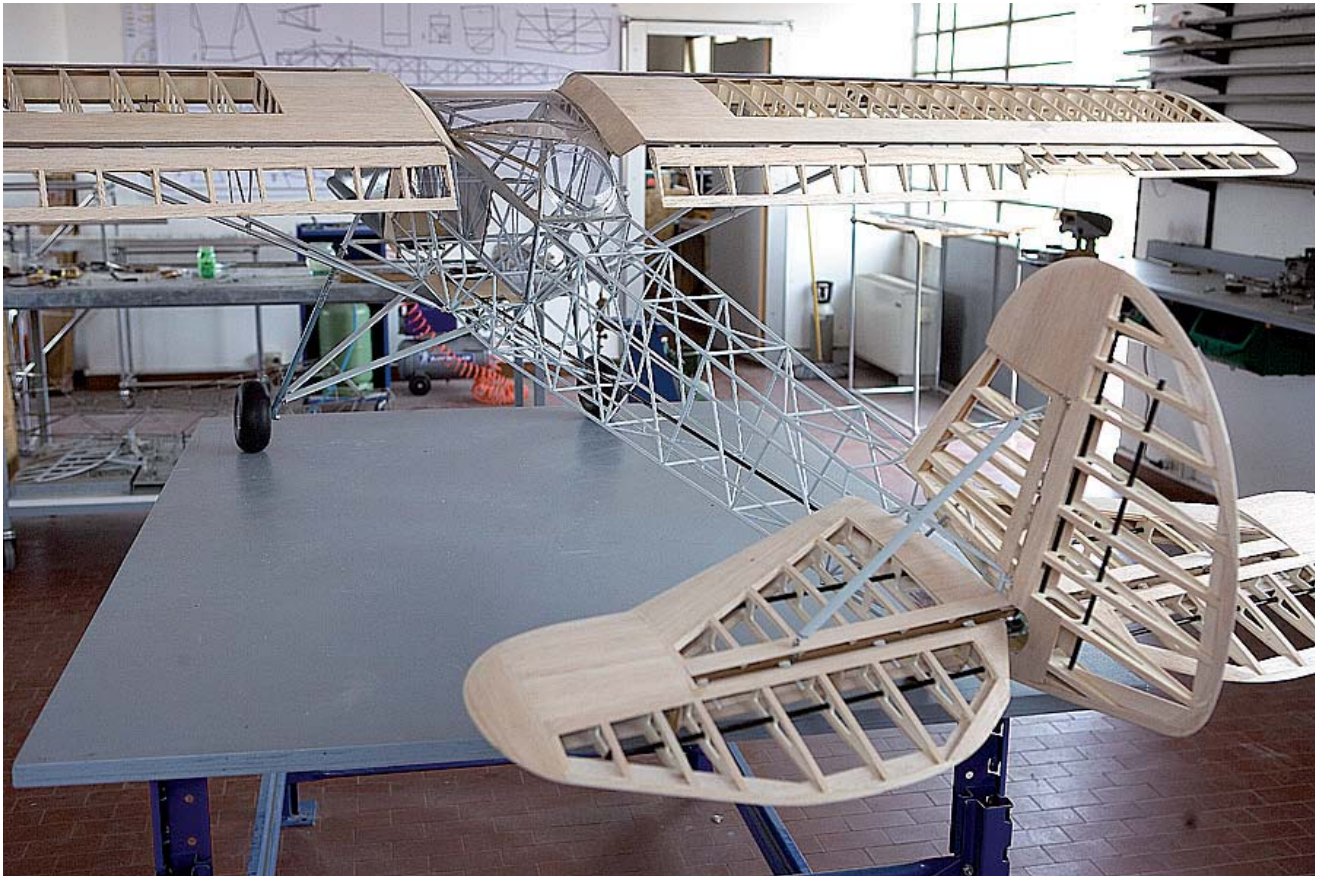
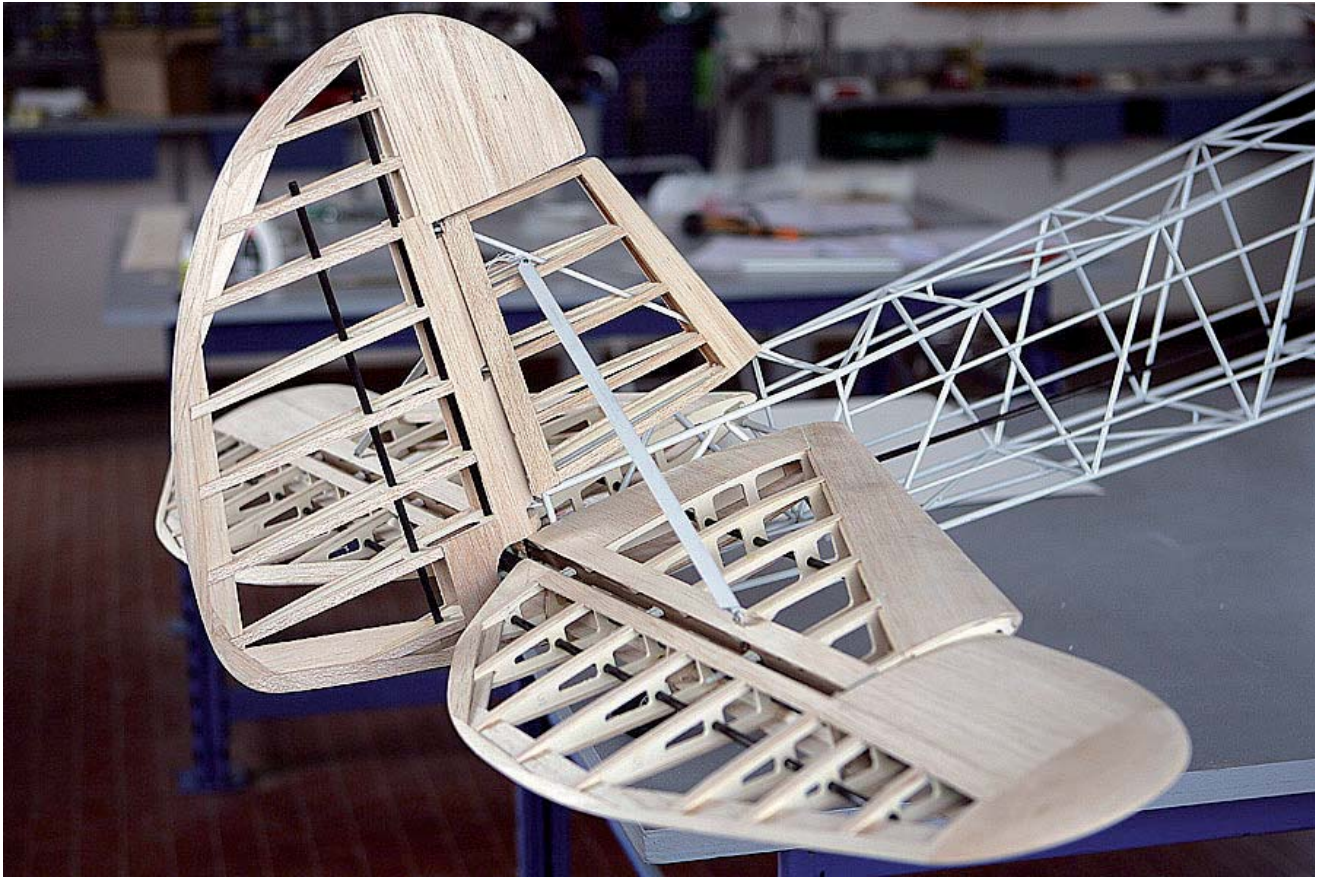

2

TAIL SURFACES

NOTE:

The pictures are of the prototype.
In the serial production we have made some improvements.

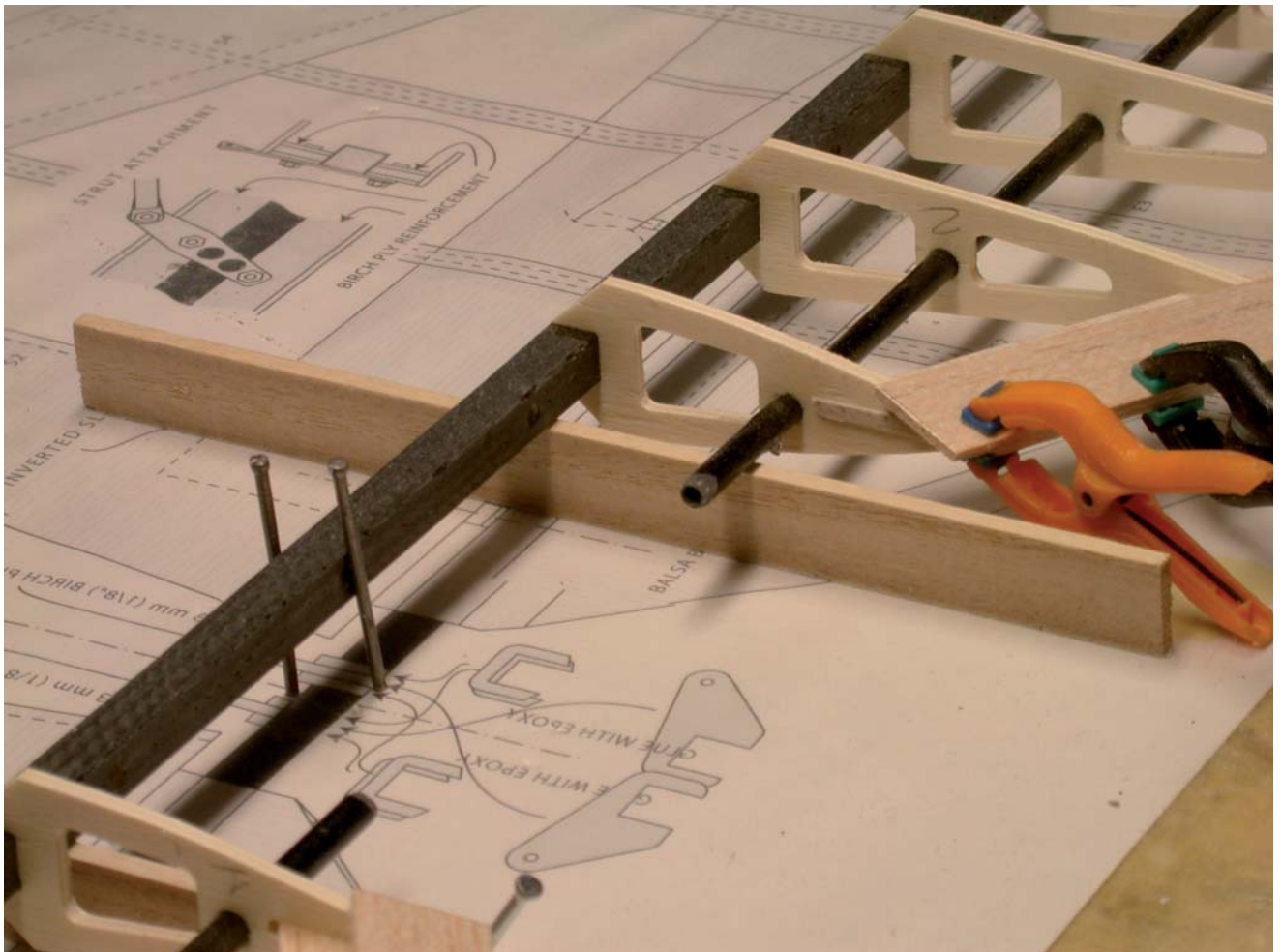
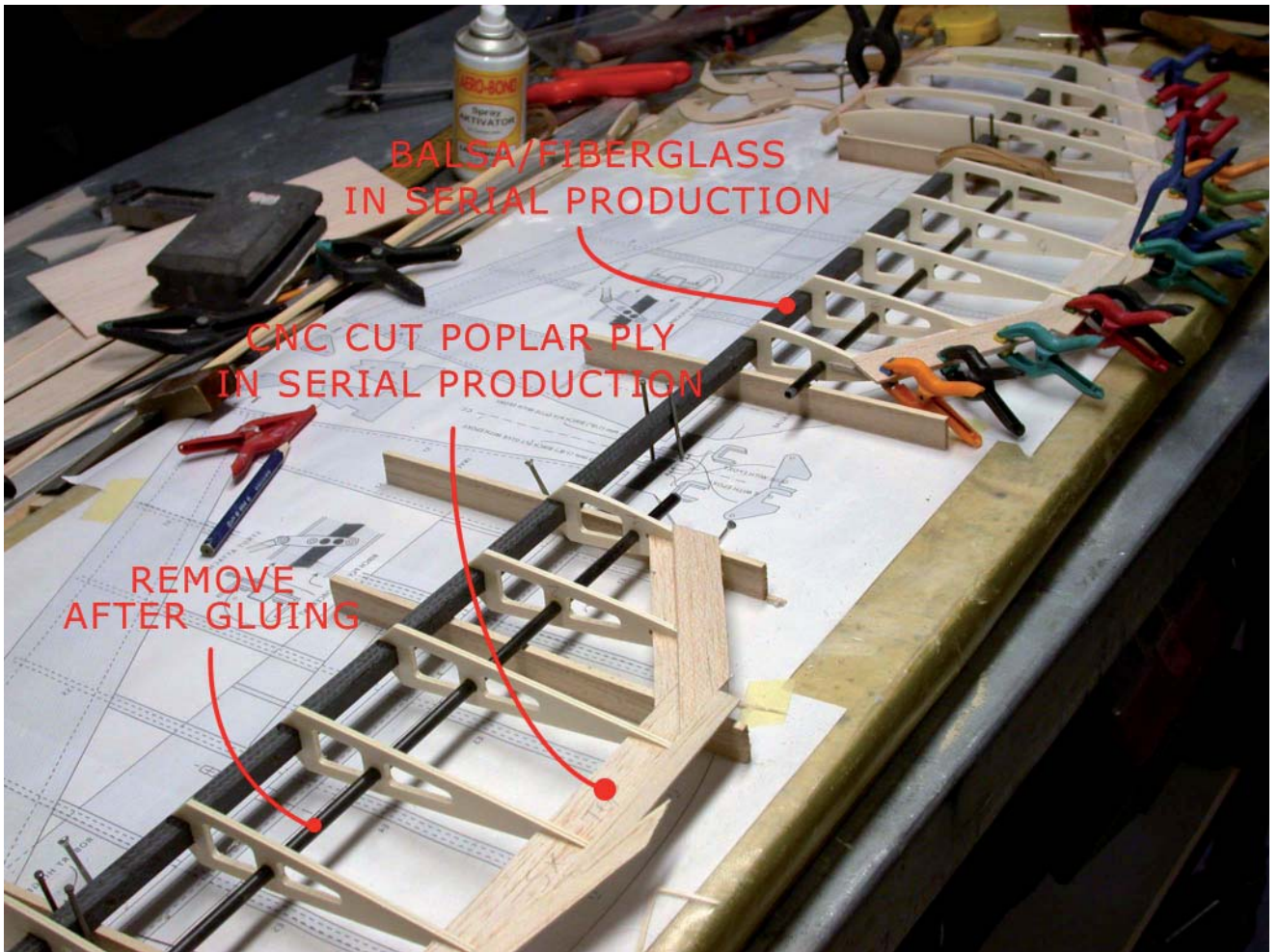

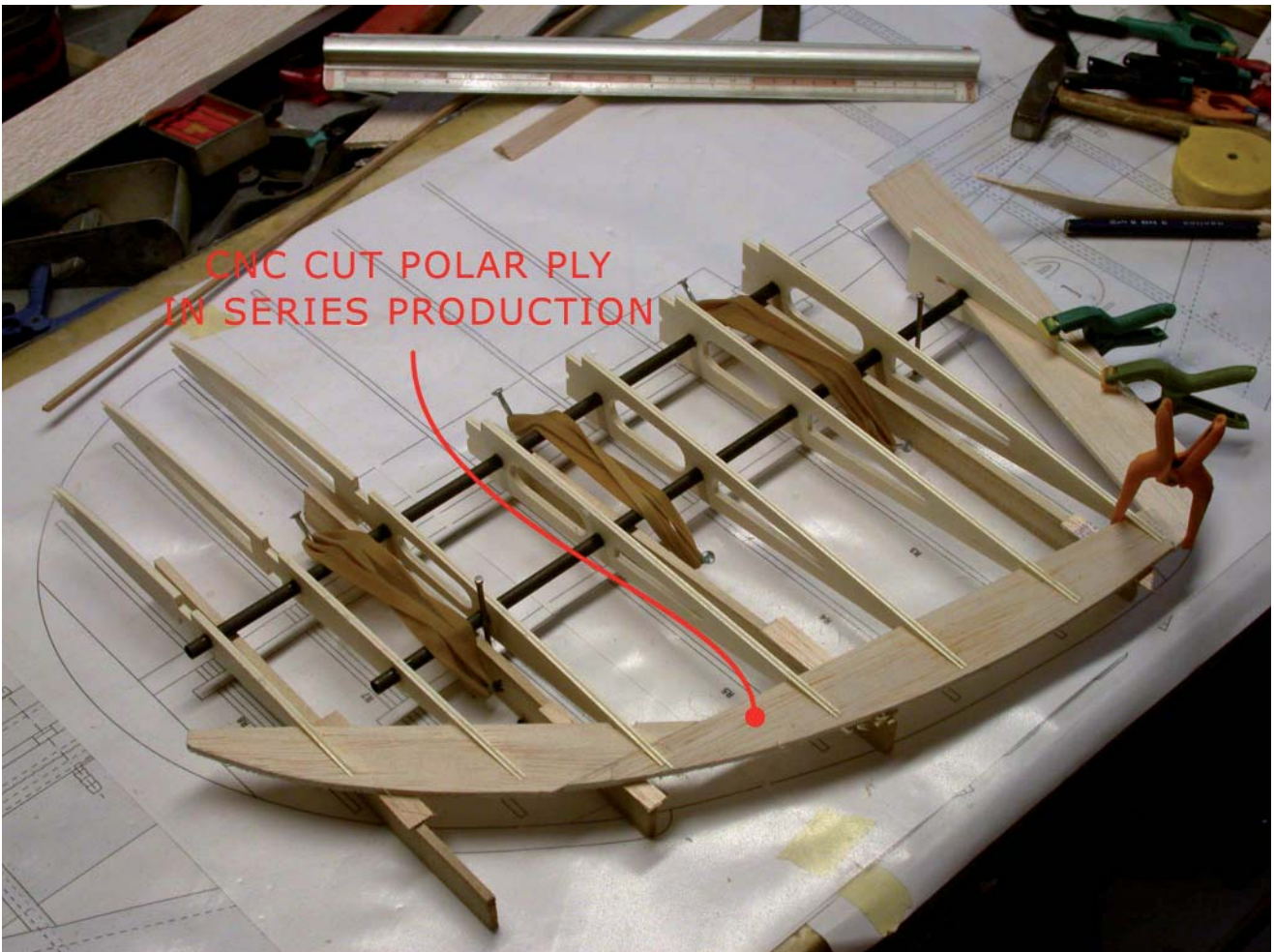
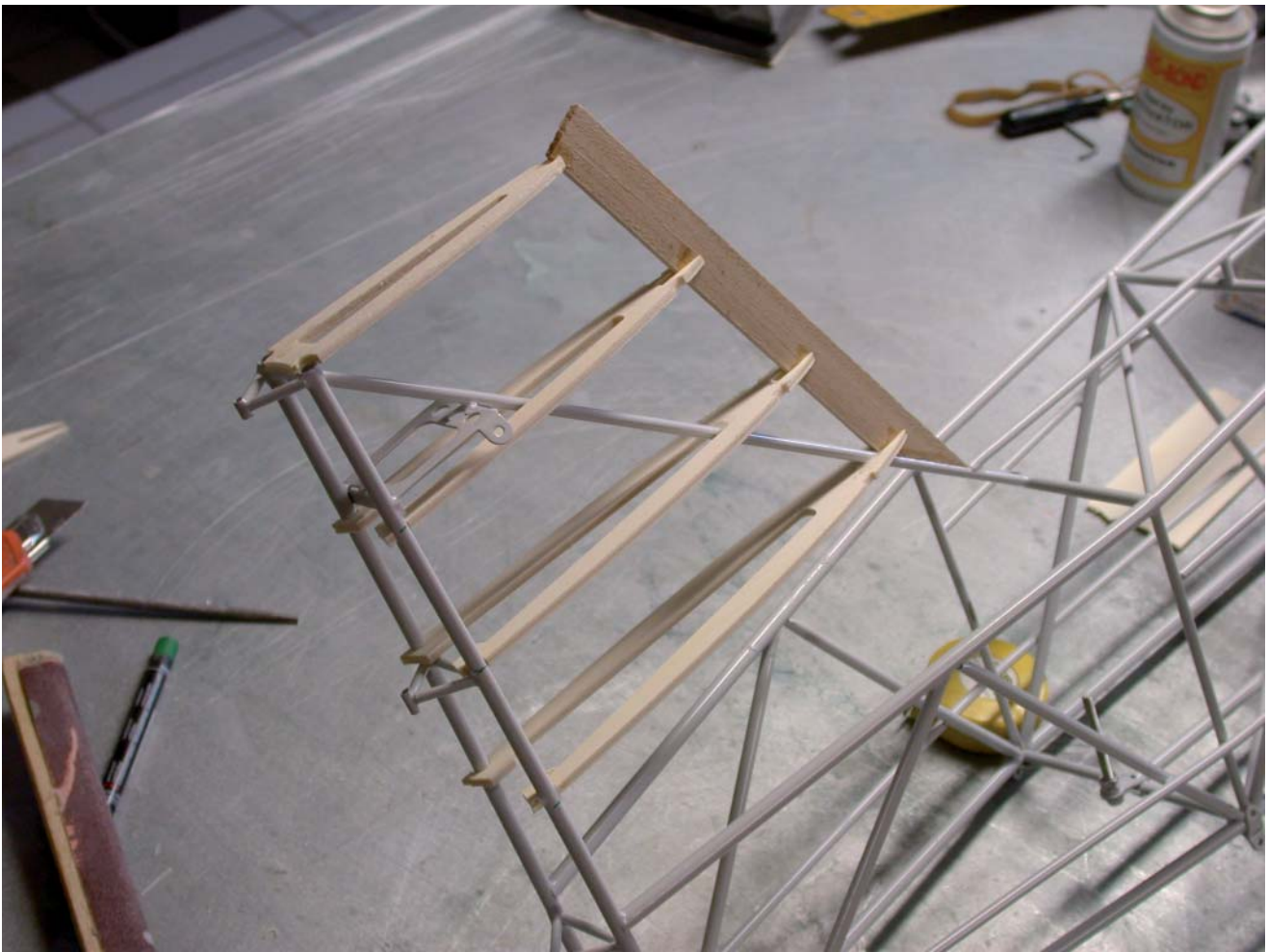

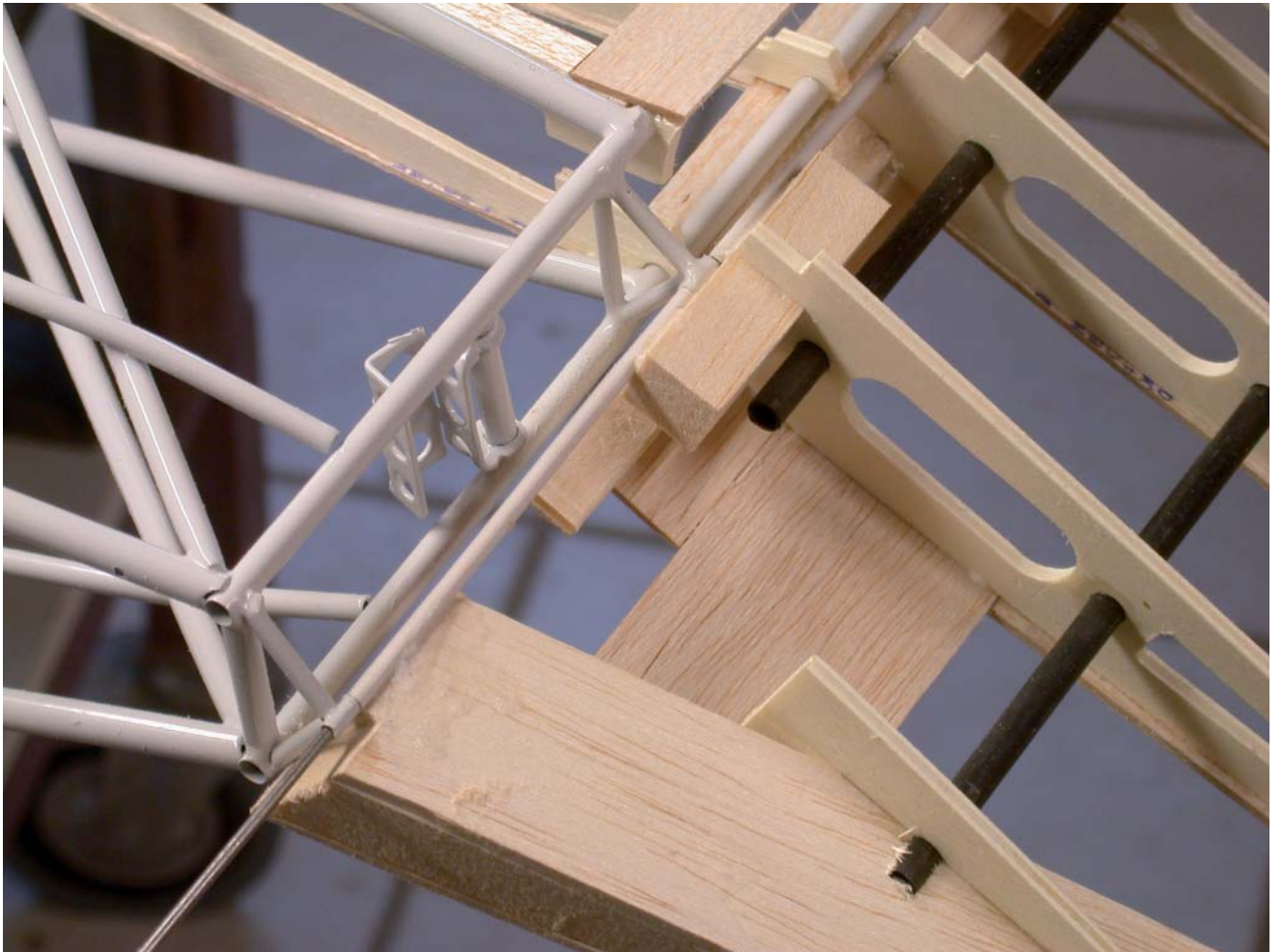

3 WINGS

NOTE:

The pictures are of the prototype.
In the serial production we have made some improvements.

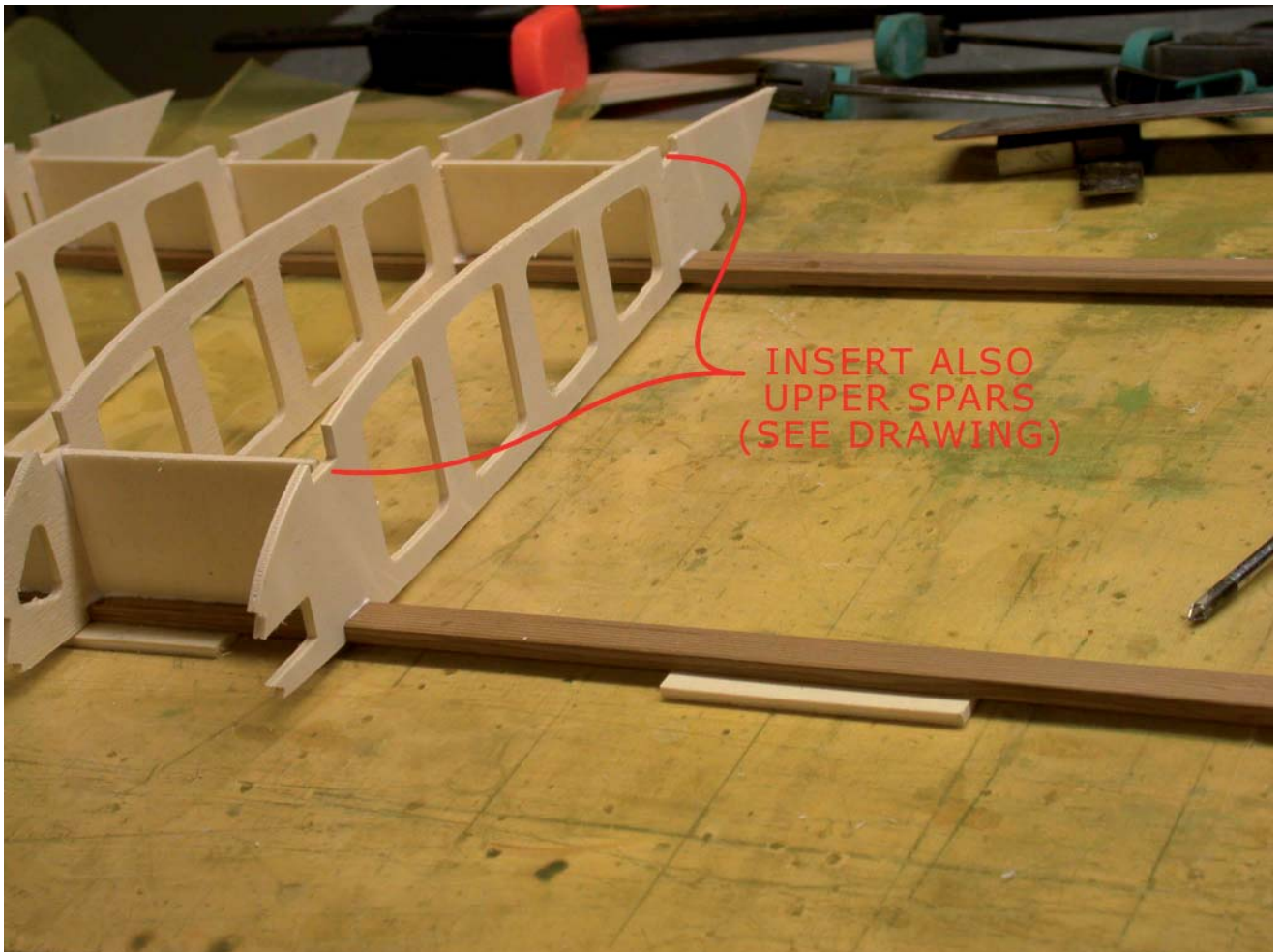
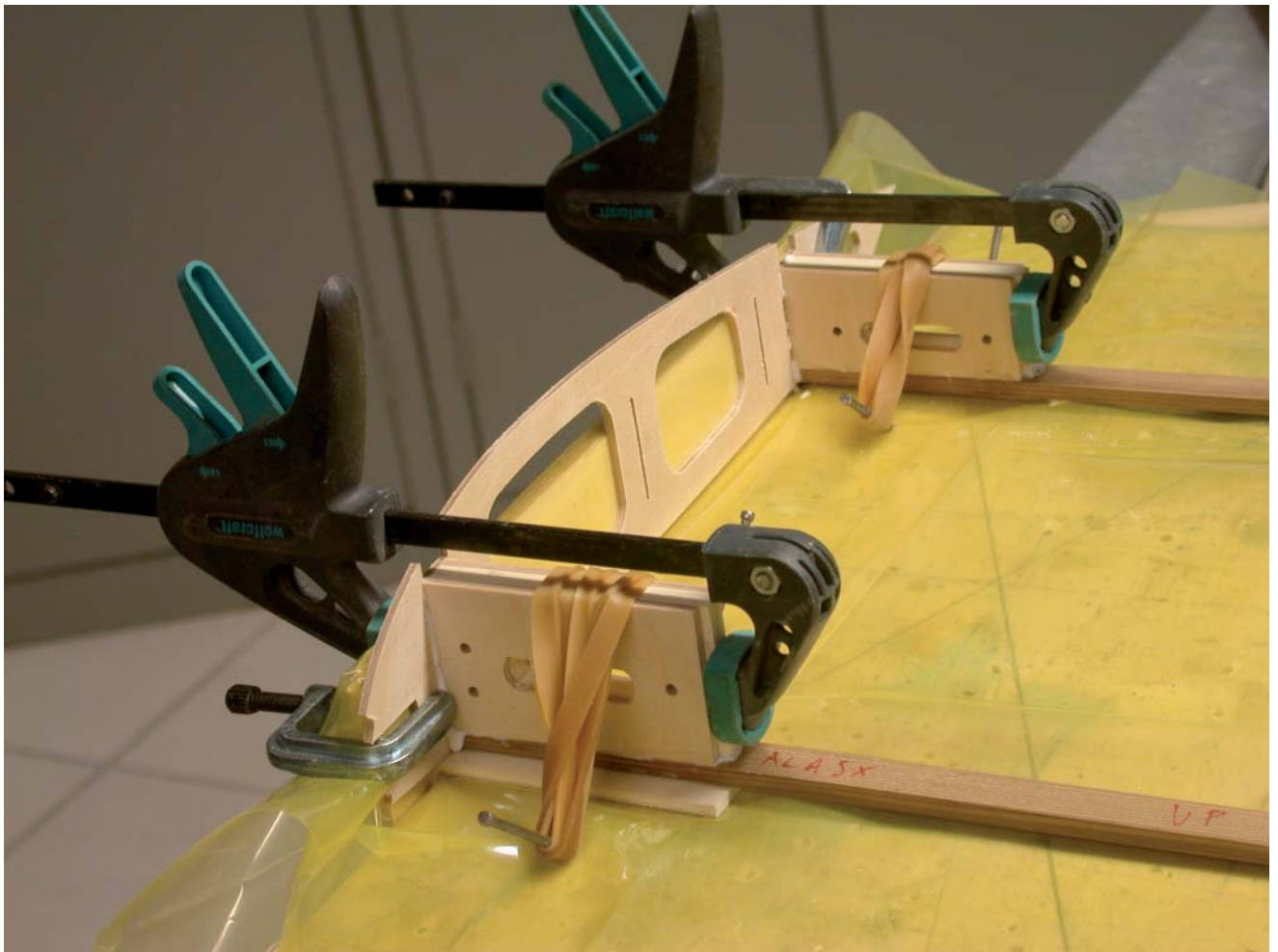

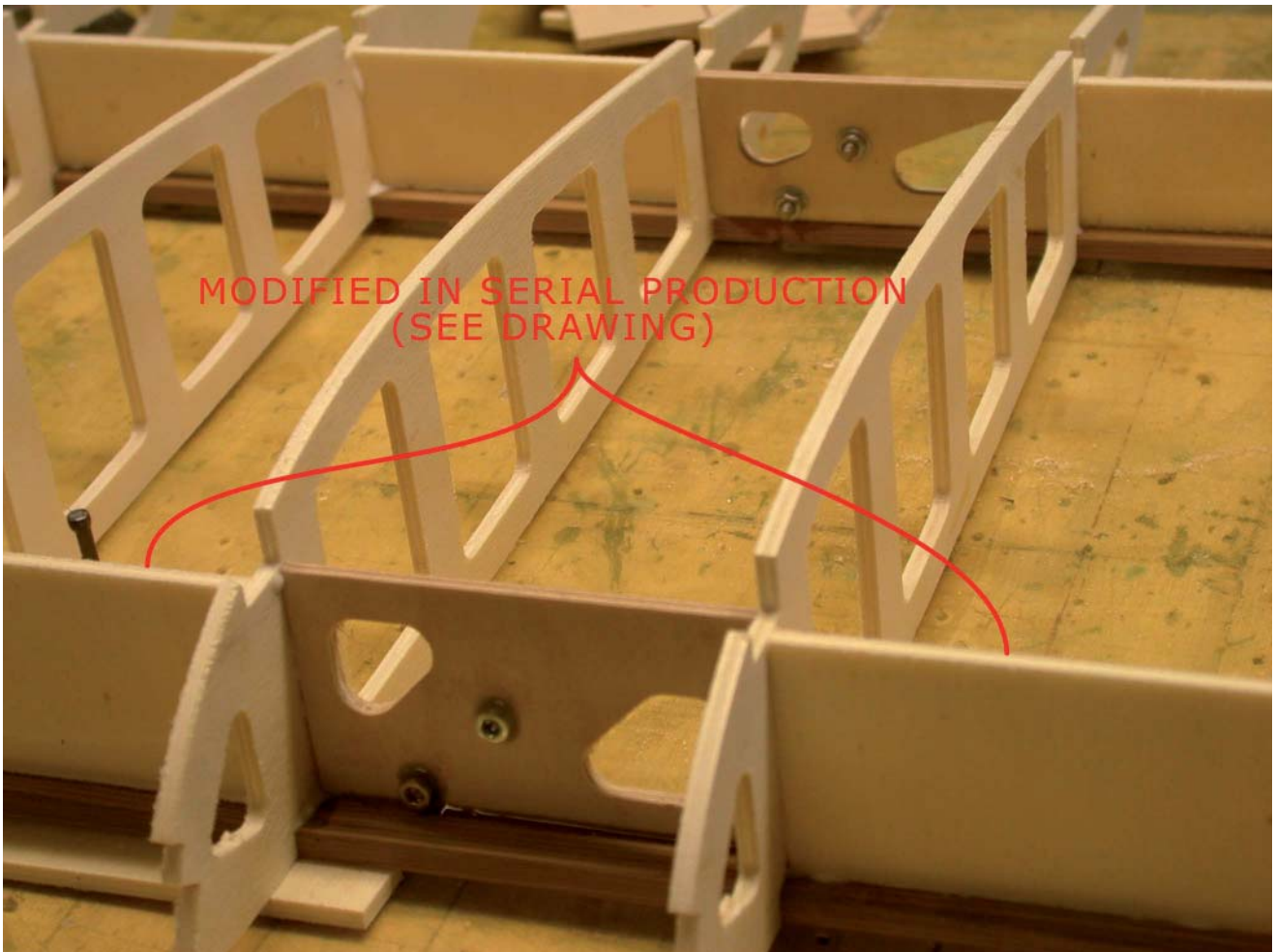
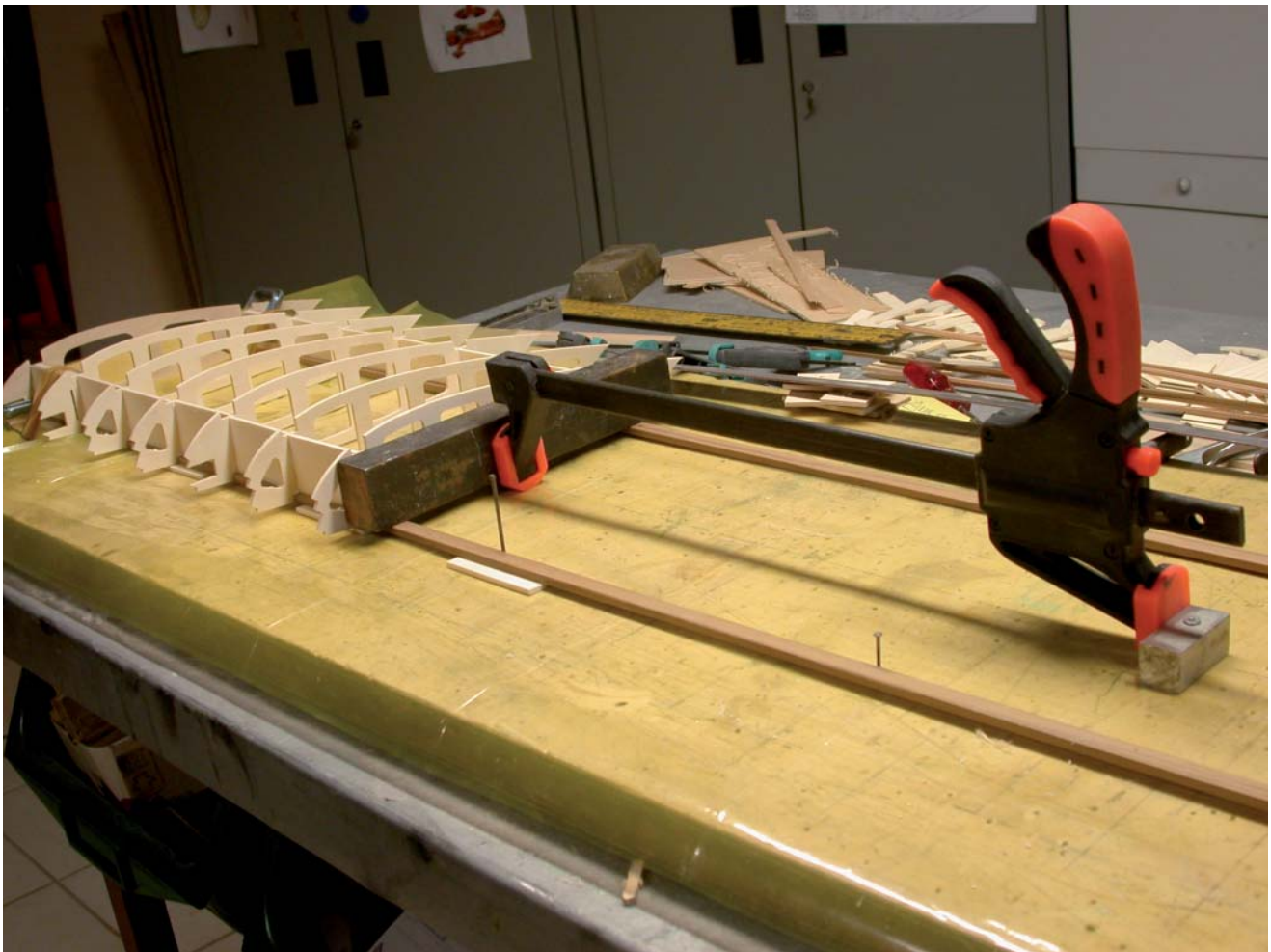

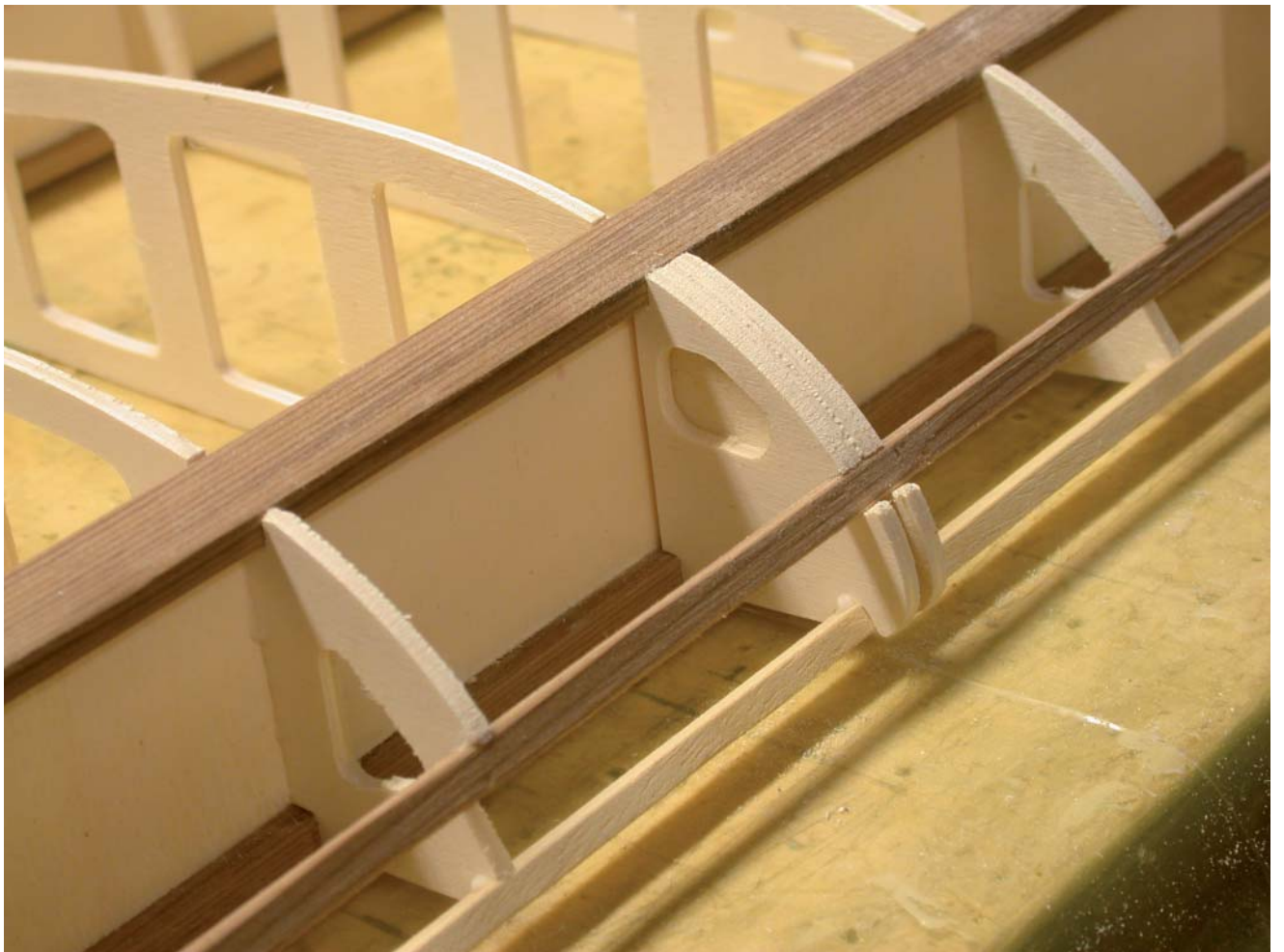
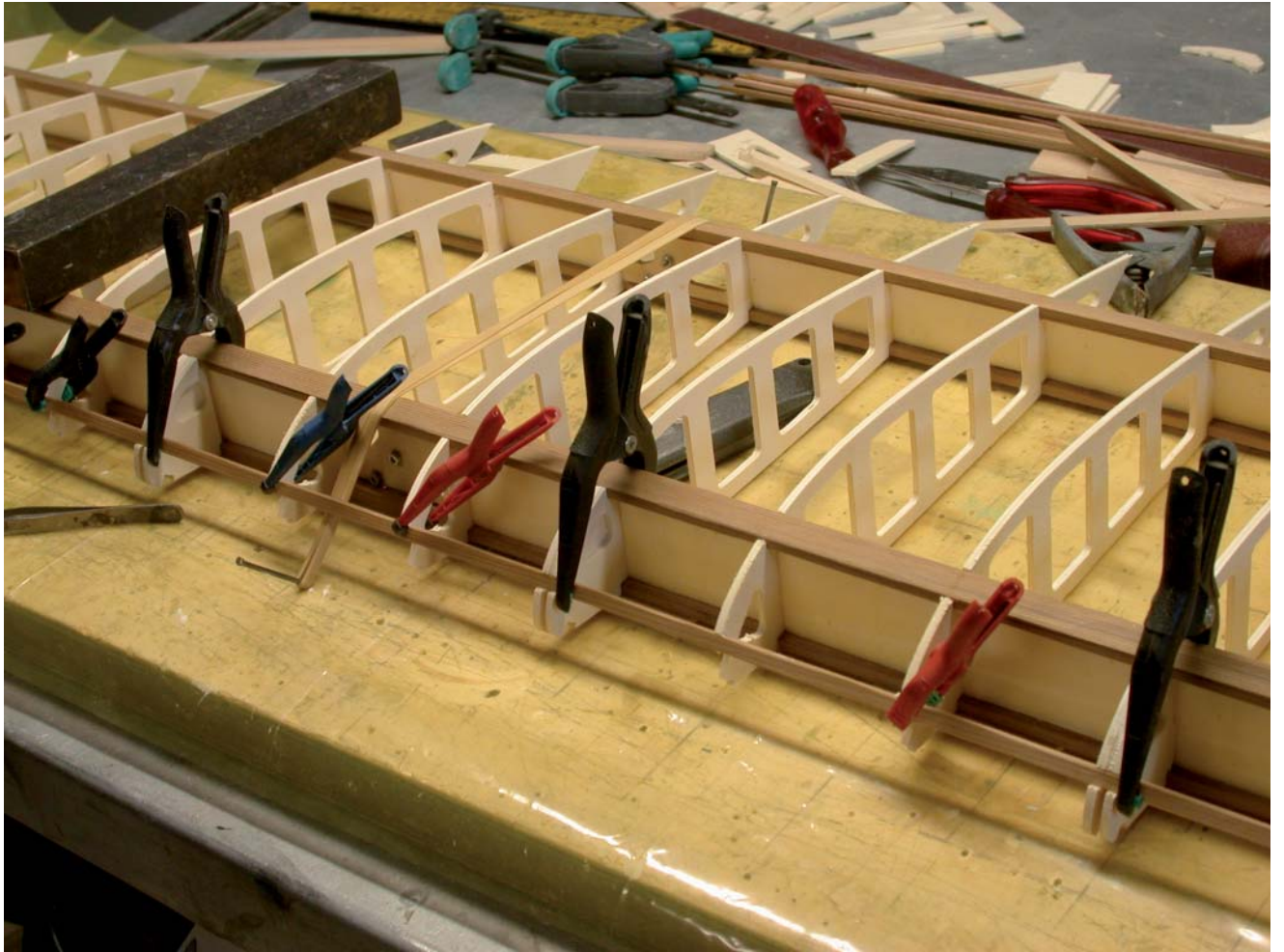

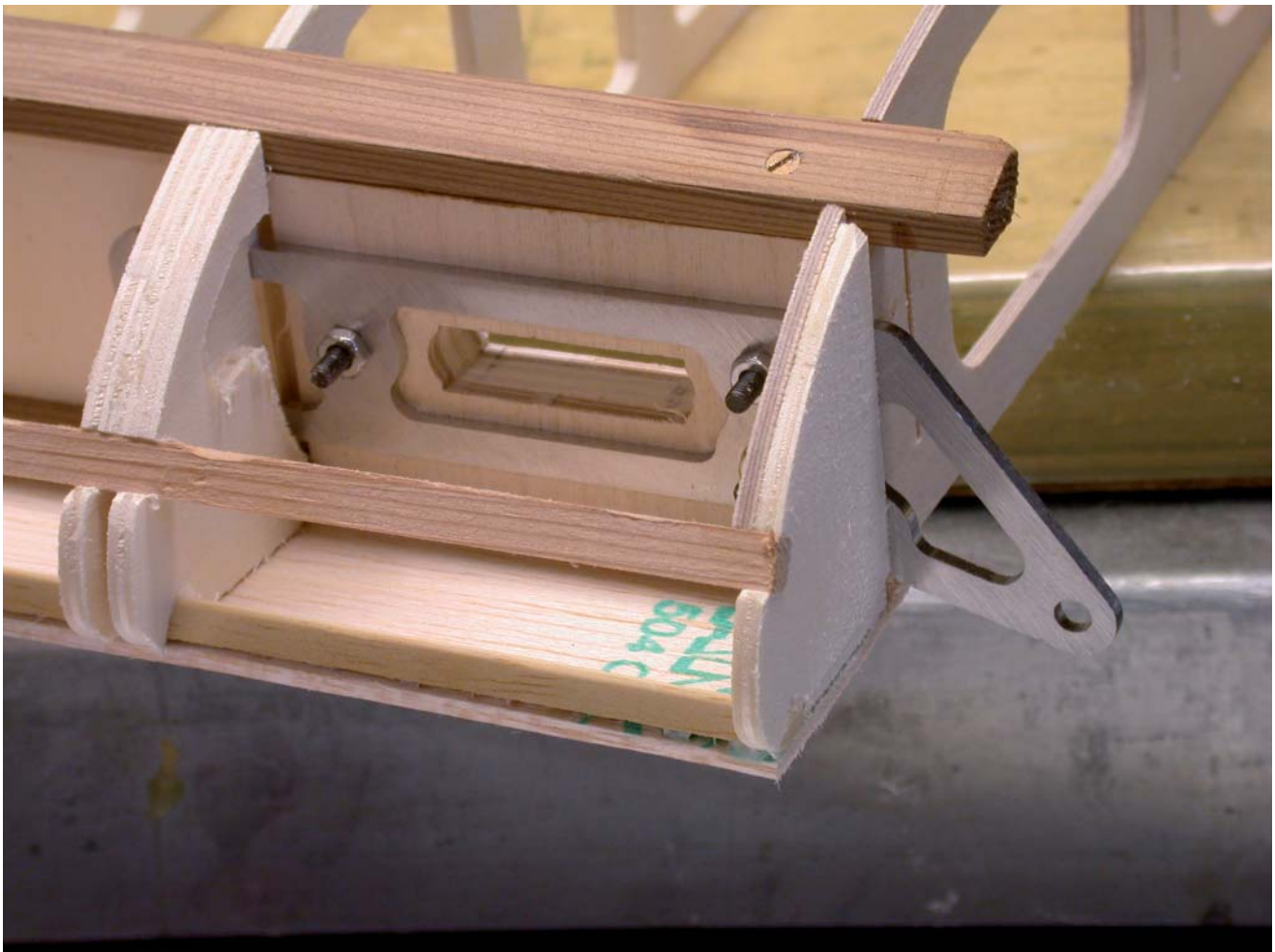

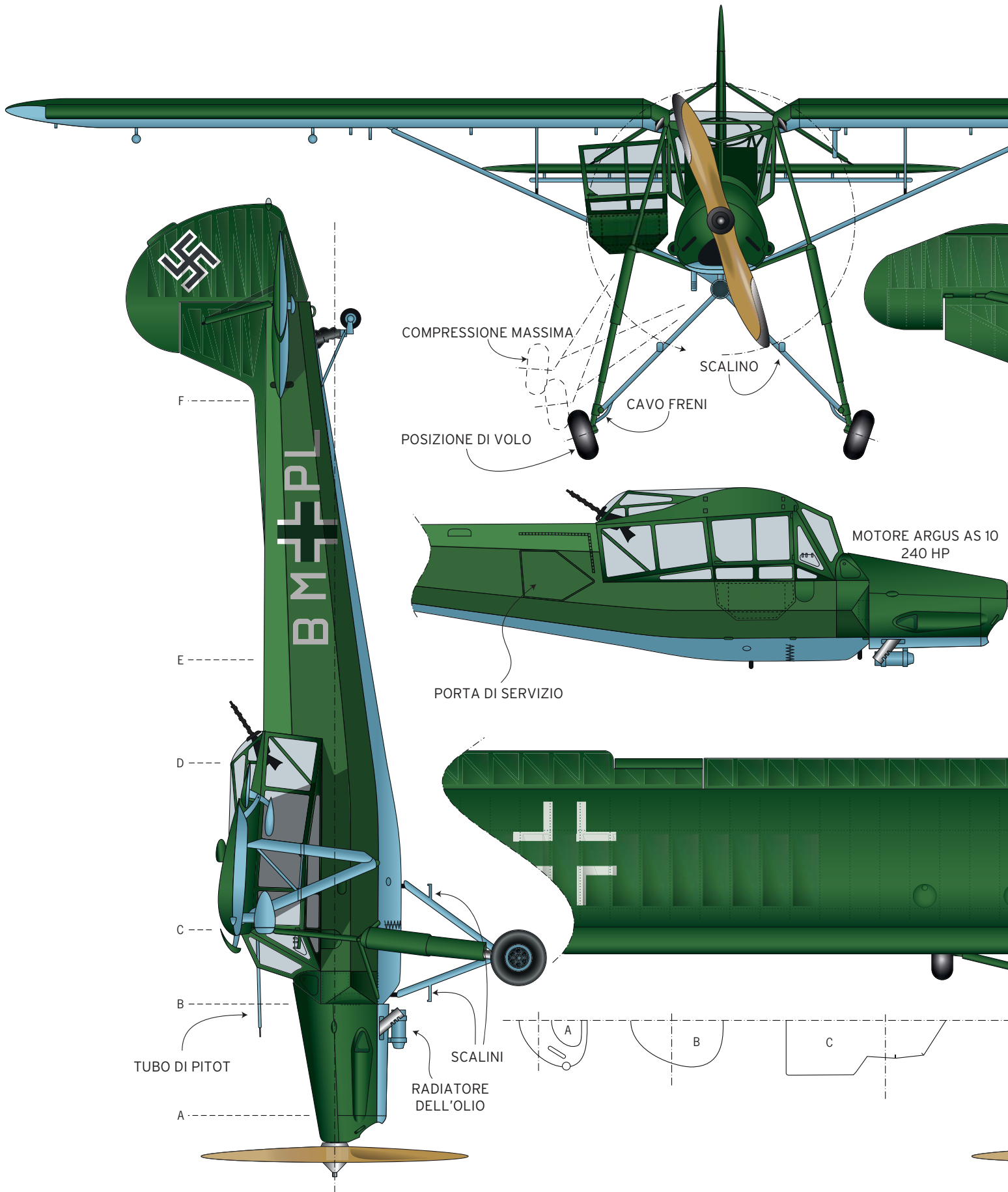

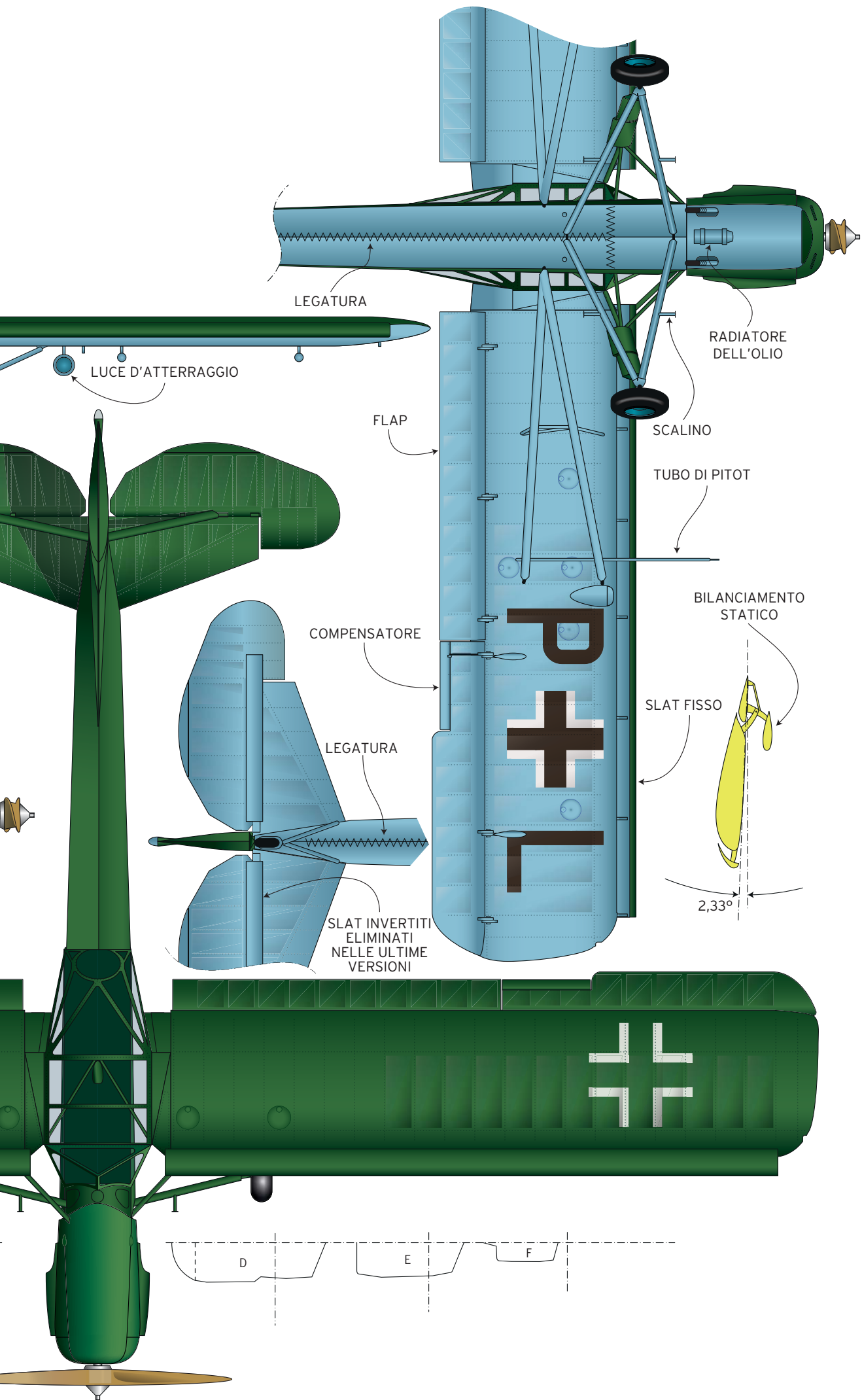



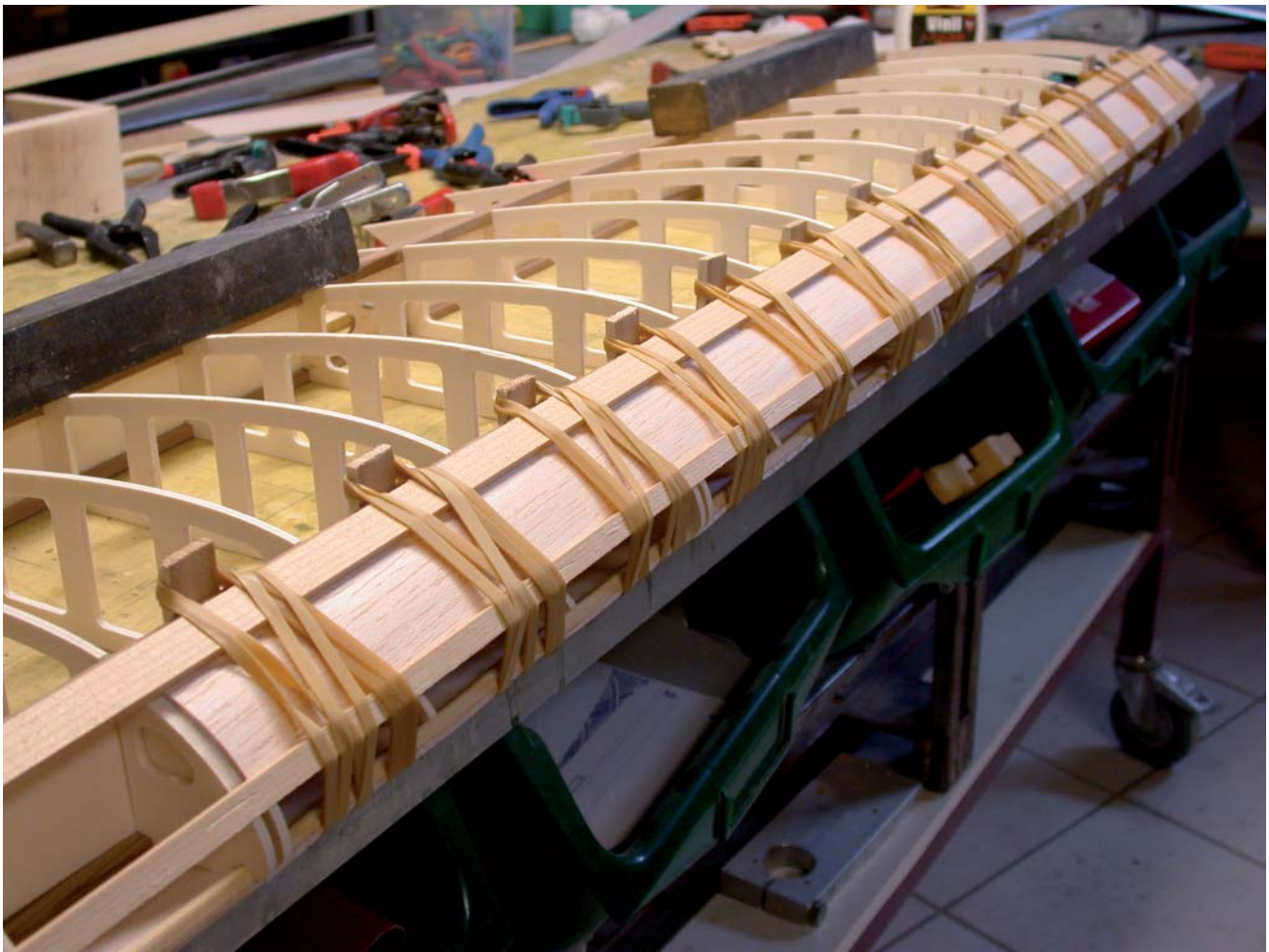





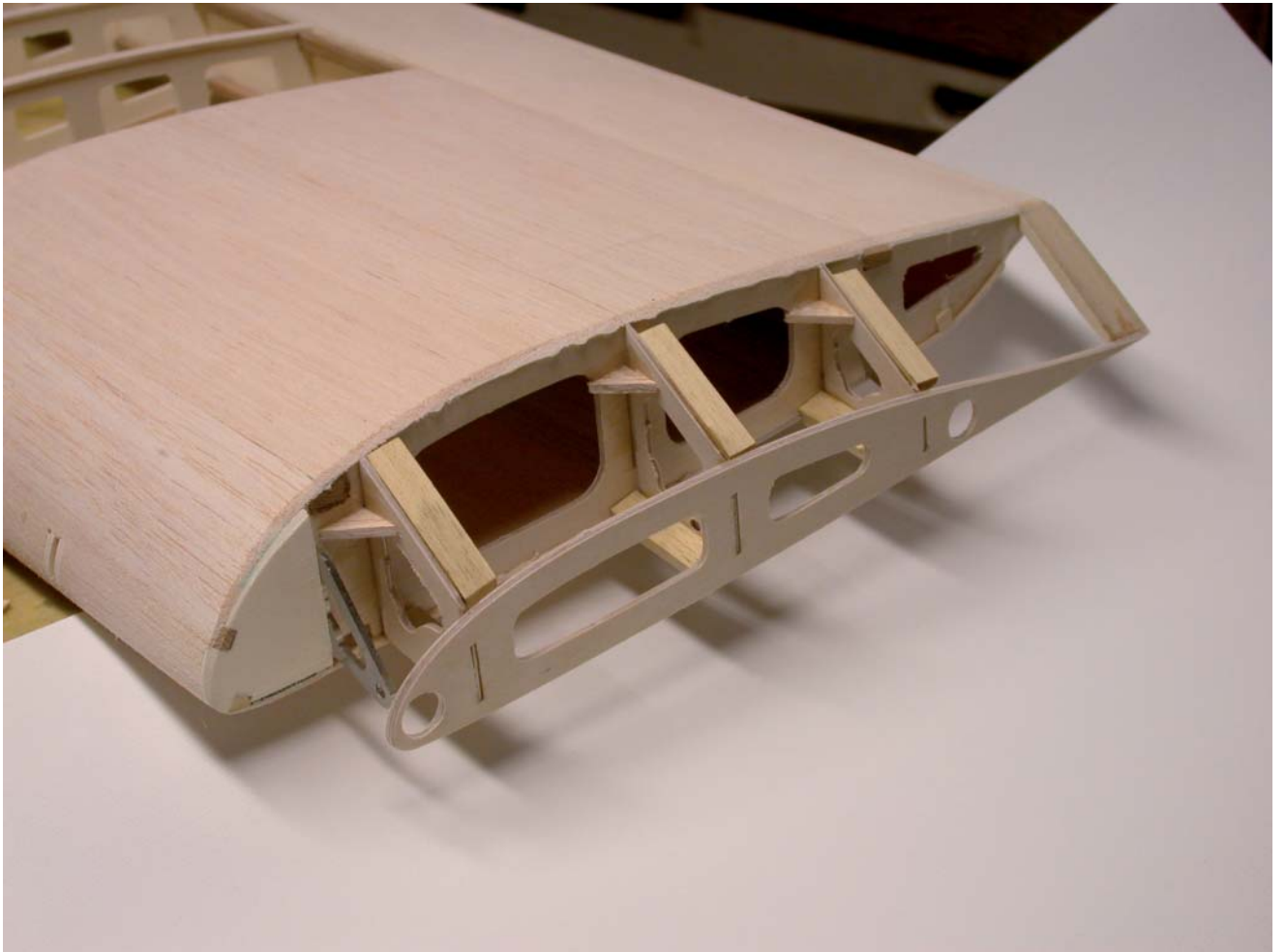
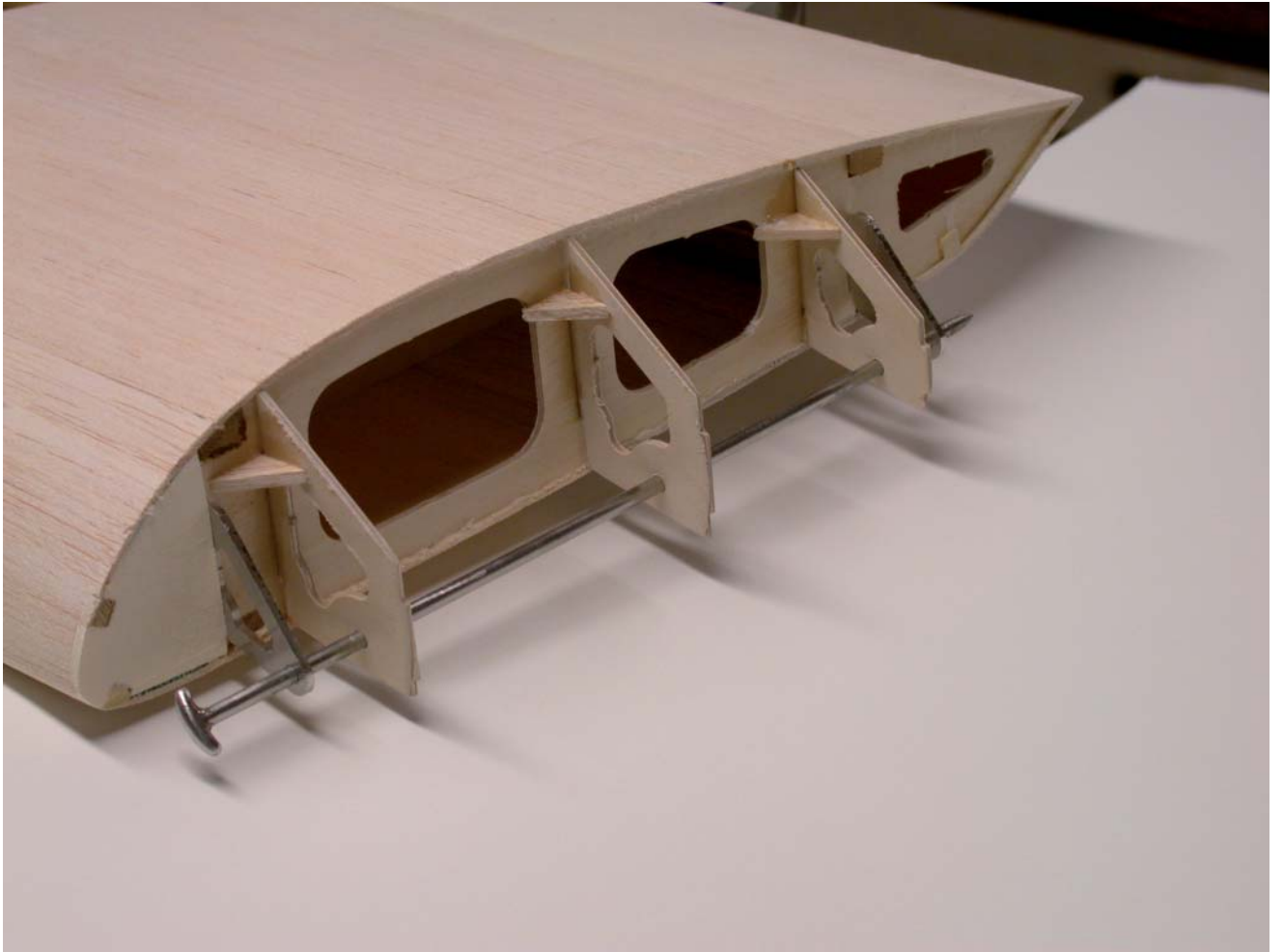



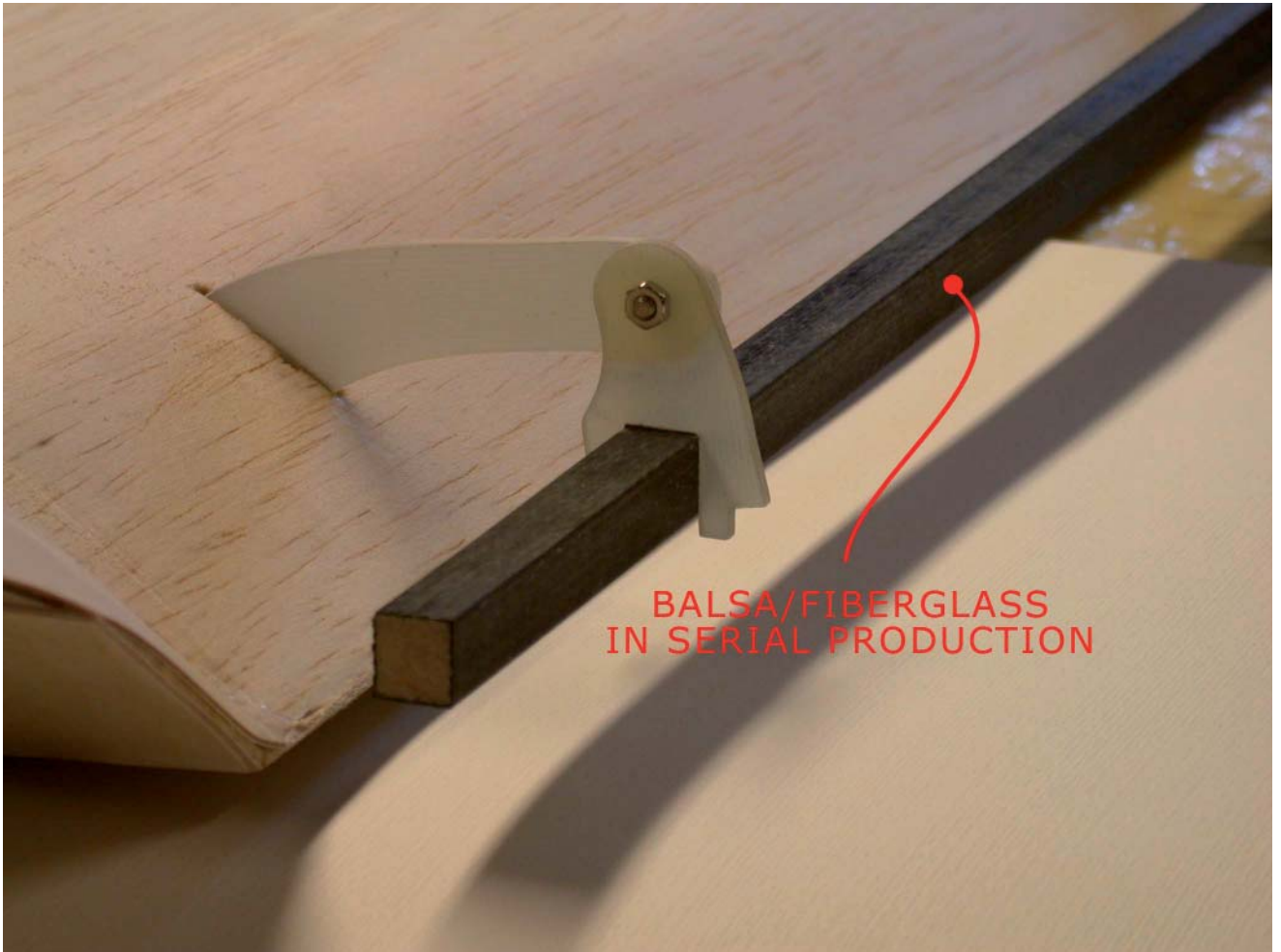





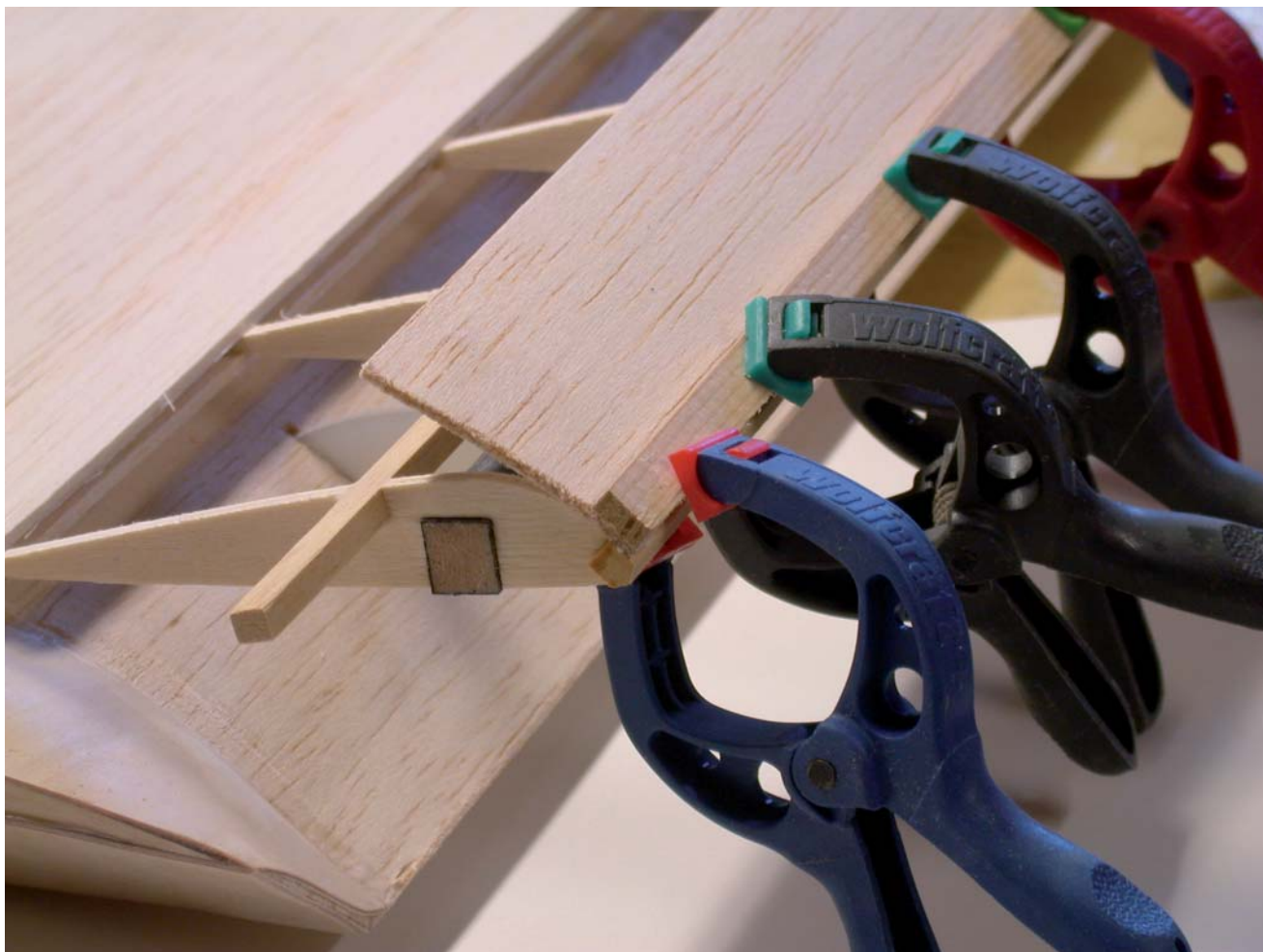

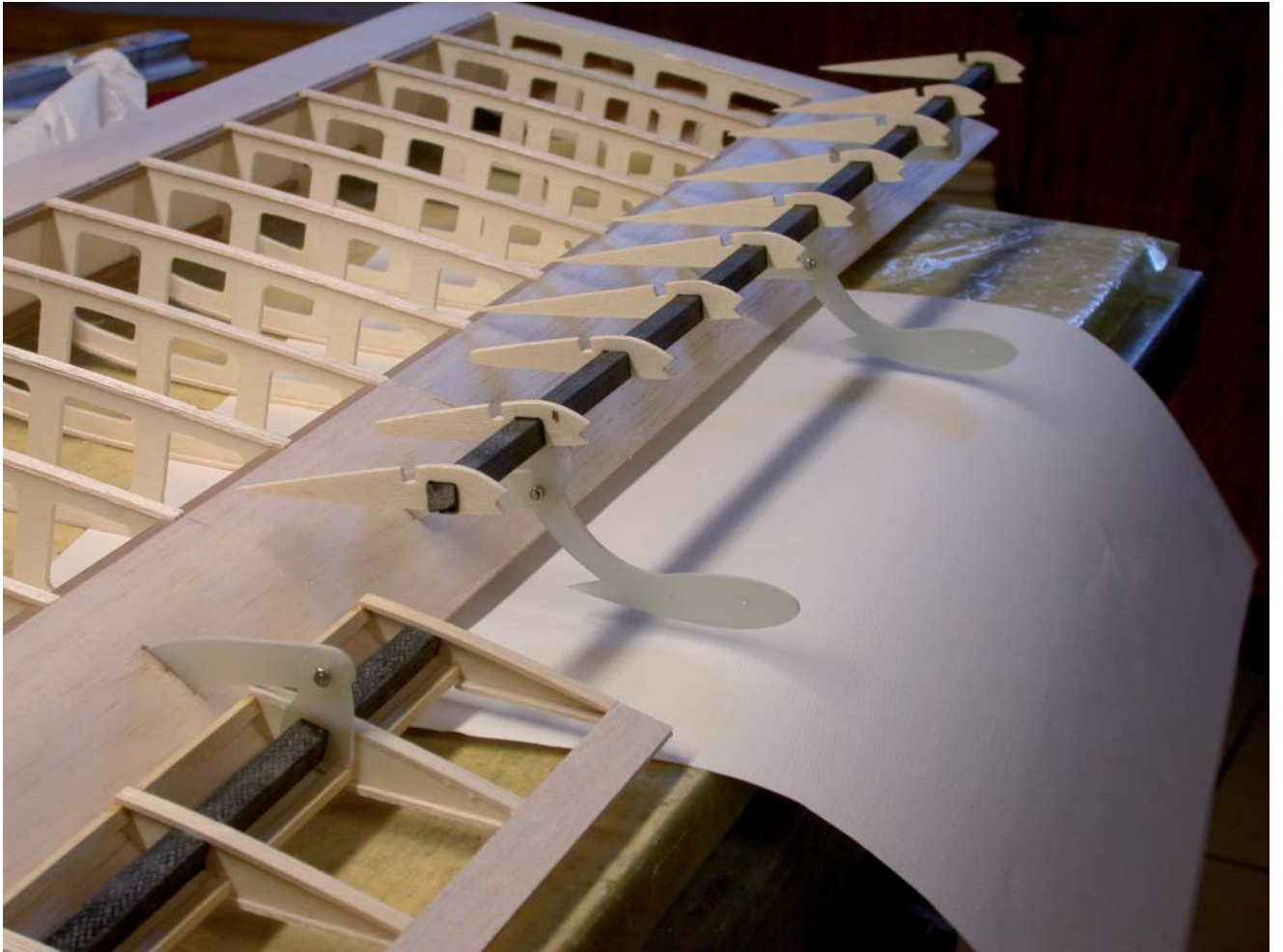

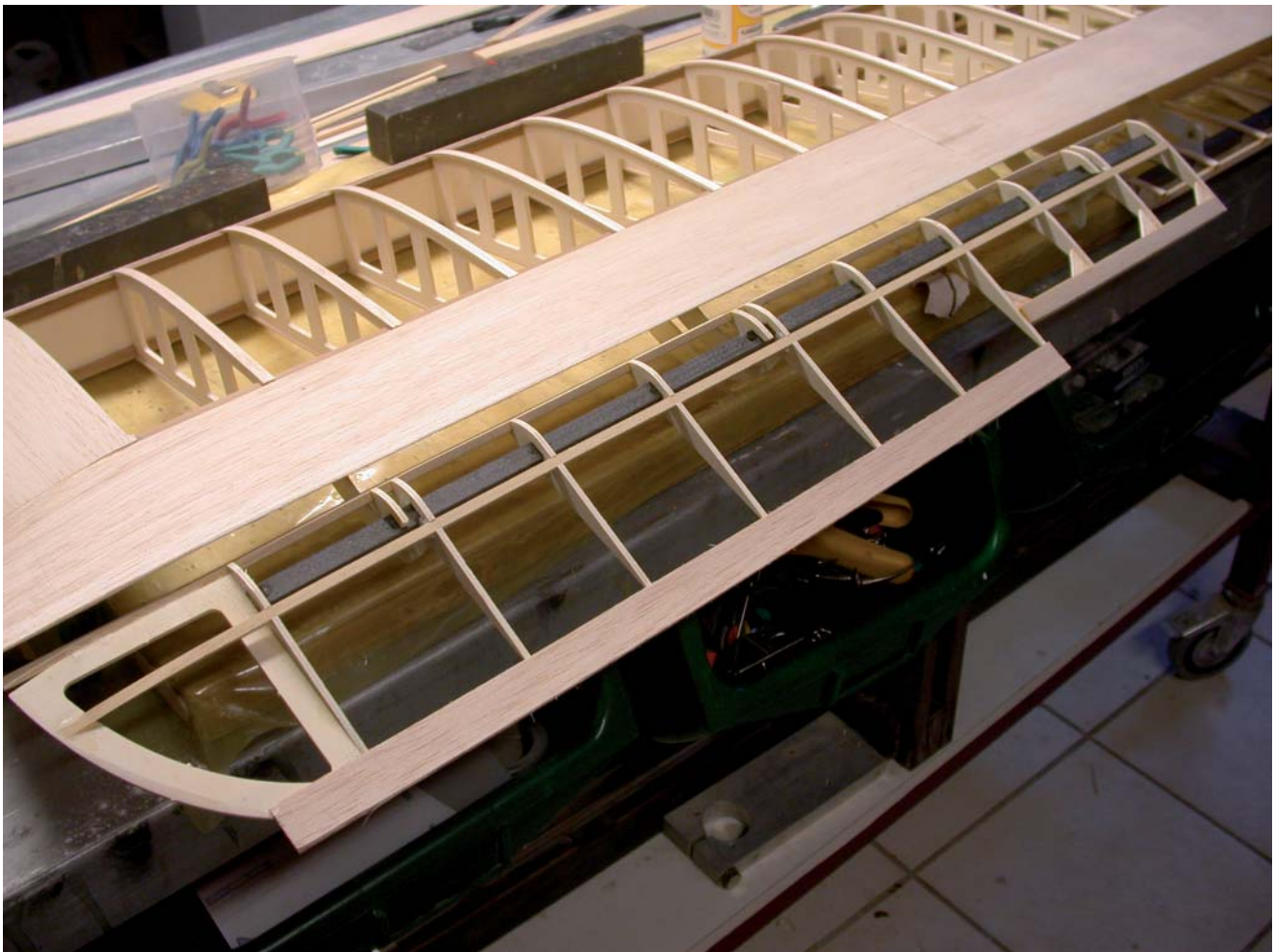

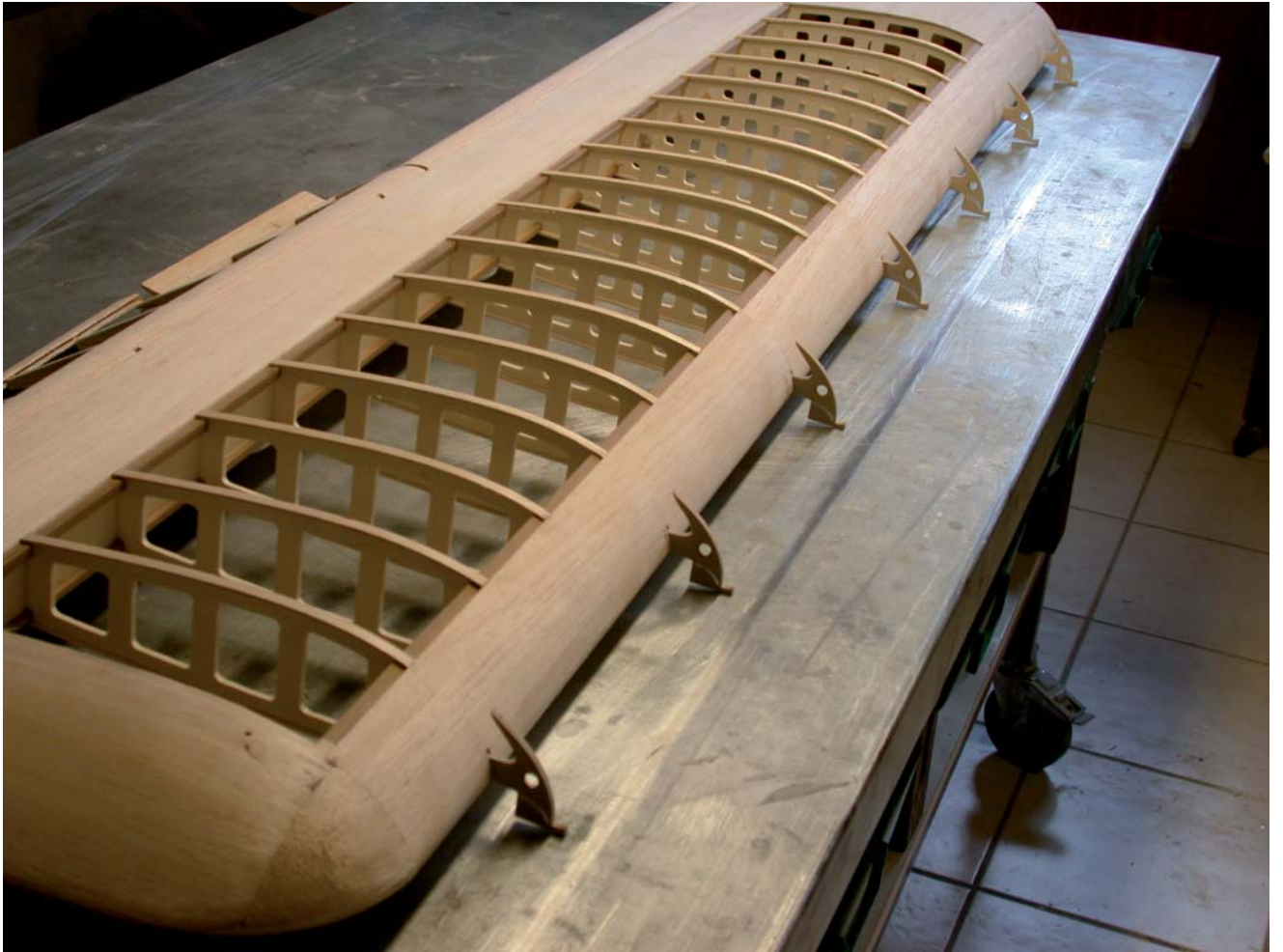





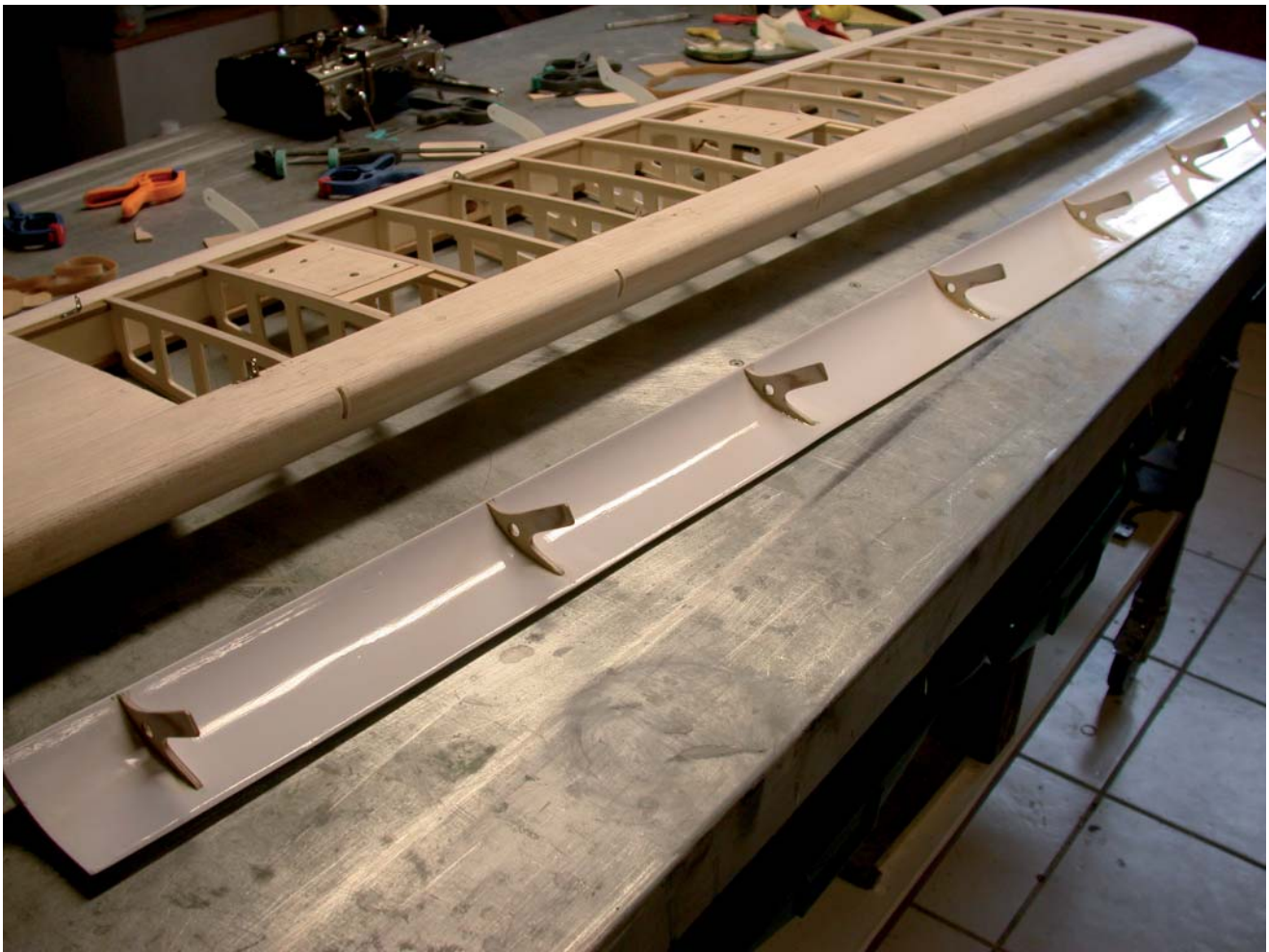

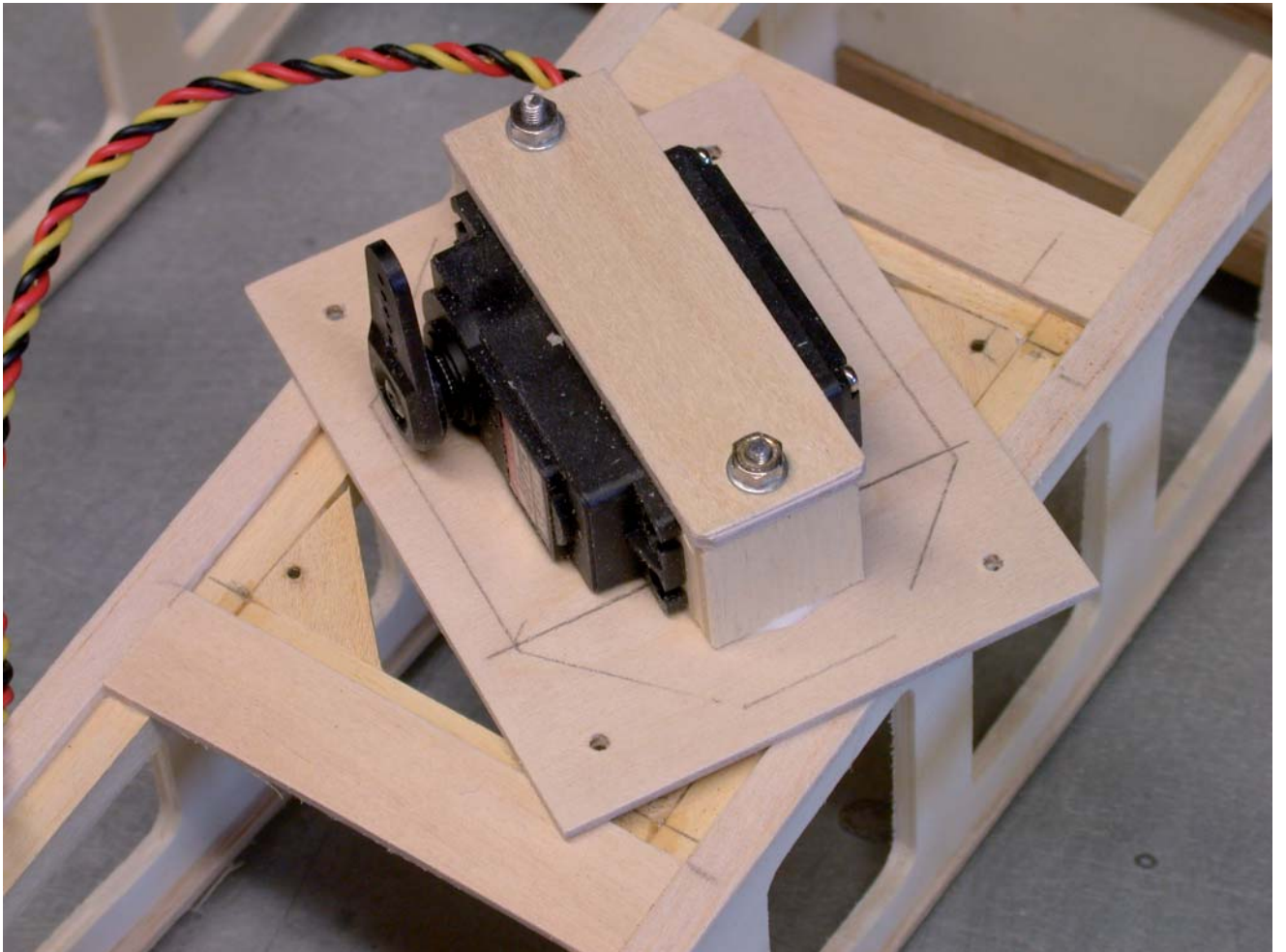





COVERING SEQUENCE

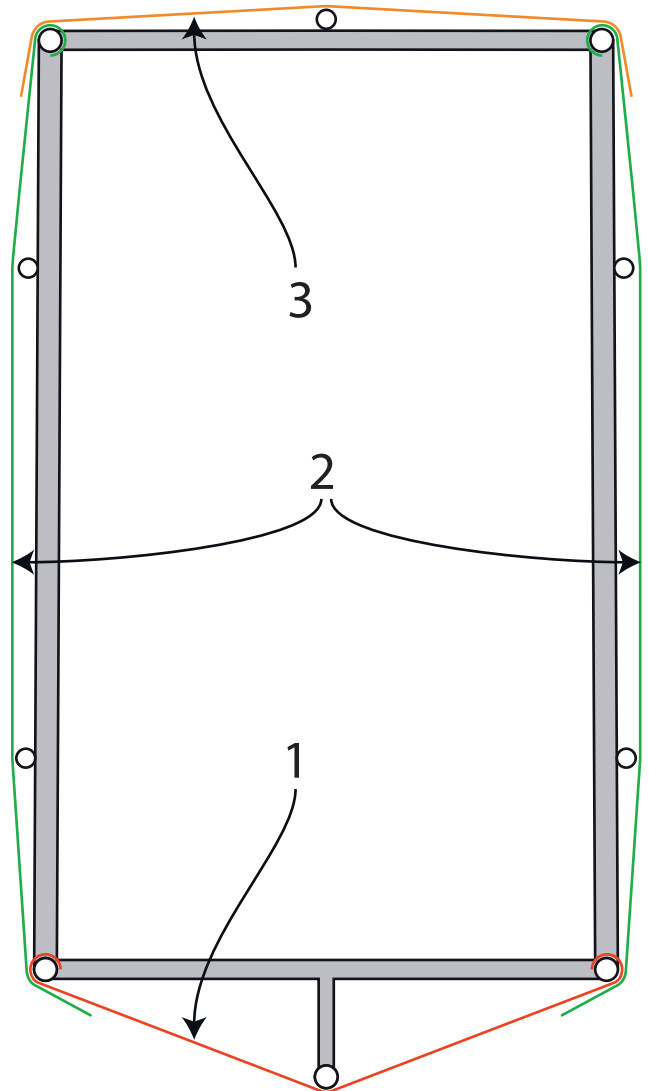
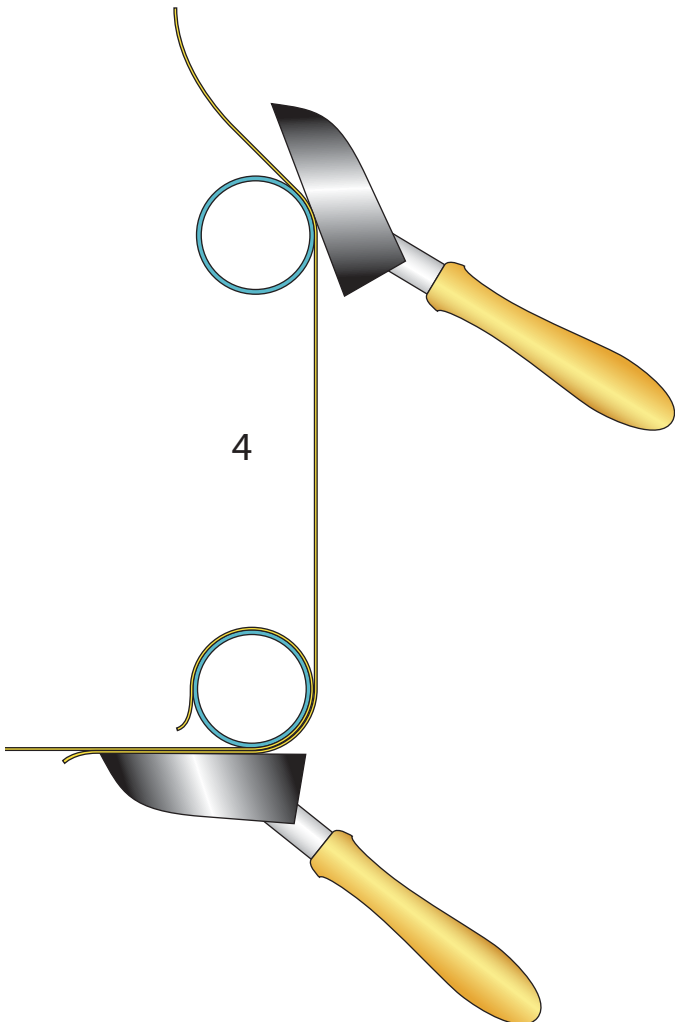
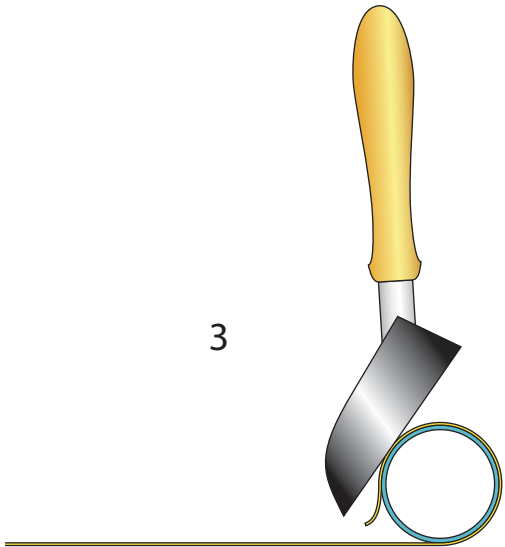
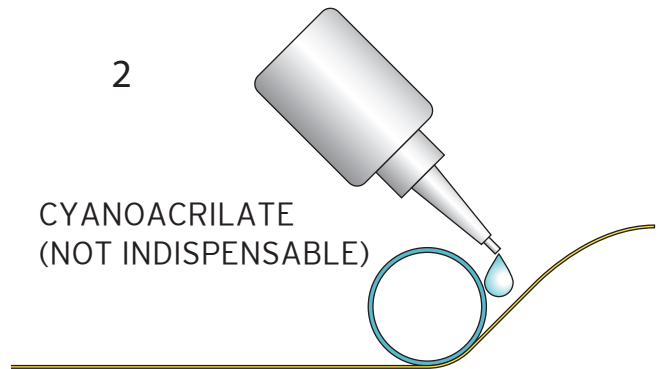
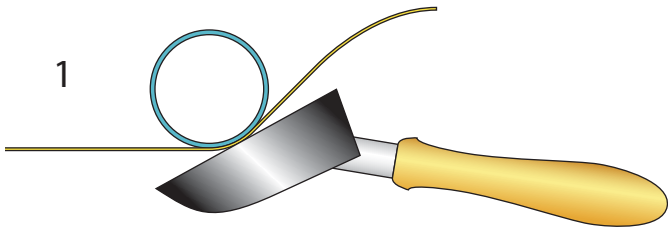





Fieseler Fi 156 "Storch" 1/4 scale

Wing span: 3542 mm. (139,44") - Length 2400 mm. (94,5")

Wing area: 175 dmq. (18,84 sq. ft.) - Weight: 11,5 kg. (25,35 lbs.) approx.

Power: 50 cc. (3 cu. in.) four stroke, (Laser 300 suggested)

Projected and drawn by Paolo Severin - December 2003

www.paoloseverin.it

Paolo Severin srl

Via Decorati al Valor Civile 57a

35142 Padova - Italy

Laboratorio: Via Monfalcone 11 - Padova

Tel. 049 8800329 - Cell. 347 0870248 - Fax 049 8800354

email: paolo.severin@pallino.it

